

PHILIPPINE BIDDING DOCUMENTS

SUPPLY AND DELIVERY OF VARIOUS OFFICE SUPPLIES FOR THE PROCUREMENT SERVICE (PS) (FRAMEWORK AGREEMENT)

PUBLIC BIDDING NO: 20-064-2

**Sixth Edition
July 2020**

Preface

These Philippine Bidding Documents (PBDs) for the procurement of Goods through Competitive Bidding have been prepared by the Government of the Philippines for use by any branch, constitutional commission or office, agency, department, bureau, office, or instrumentality of the Government of the Philippines, National Government Agencies, including Government-Owned and/or Controlled Corporations, Government Financing Institutions, State Universities and Colleges, and Local Government Unit. The procedures and practices presented in this document have been developed through broad experience, and are for mandatory use in projects that are financed in whole or in part by the Government of the Philippines or any foreign government/foreign or international financing institution in accordance with the provisions of the 2016 revised Implementing Rules and Regulations of Republic Act No. 9184.

The Bidding Documents shall clearly and adequately define, among others: (i) the objectives, scope, and expected outputs and/or results of the proposed contract or Framework Agreement, as the case may be; (ii) the eligibility requirements of Bidders; (iii) the expected contract or Framework Agreement duration, the estimated quantity in the case of procurement of goods, delivery schedule and/or time frame; and (iv) the obligations, duties, and/or functions of the winning bidder.

Care should be taken to check the relevance of the provisions of the PBDs against the requirements of the specific Goods to be procured. If duplication of a subject is inevitable in other sections of the document prepared by the Procuring Entity, care must be exercised to avoid contradictions between clauses dealing with the same matter.

Moreover, each section is prepared with notes intended only as information for the Procuring Entity or the person drafting the Bidding Documents. They shall not be included in the final documents. The following general directions should be observed when using the documents:

- a. All the documents listed in the Table of Contents are normally required for the procurement of Goods. However, they should be adapted as necessary to the circumstances of the particular Procurement Project.
- b. Specific details, such as the “*name of the Procuring Entity*” and “*address for bid submission*,” should be furnished in the Instructions to Bidders, Bid Data Sheet, and Special Conditions of Contract. The final documents should contain neither blank spaces nor options.
- c. This Preface and the footnotes or notes in italics included in the Invitation to Bid, Bid Data Sheet, General Conditions of Contract, Special Conditions of

Contract, Schedule of Requirements, and Specifications are not part of the text of the final document, although they contain instructions that the Procuring Entity should strictly follow.

- d. The cover should be modified as required to identify the Bidding Documents as to the Procurement Project, Project Identification Number, and Procuring Entity, in addition to the date of issue.
- e. Modifications for specific Procurement Project details should be provided in the Special Conditions of Contract as amendments to the Conditions of Contract. For easy completion, whenever reference has to be made to specific clauses in the Bid Data Sheet or Special Conditions of Contract, these terms shall be printed in bold typeface on Sections I (Instructions to Bidders) and III (General Conditions of Contract), respectively.
- f. For guidelines on the use of Bidding Forms and the procurement of Foreign-Assisted Projects, these will be covered by a separate issuance of the Government Procurement Policy Board.

Table of Contents

Glossary of Acronyms, Terms, and Abbreviations.....	5
Section I. Invitation to Bid.....	8
Section II. Instructions to Bidders	12
1. Scope of Bid	13
2. Funding Information	13
3. Bidding Requirements	13
The Bidder, by the act of submitting its Bid, shall be deemed to have verified and accepted the general requirements of this Project, including other factors that may affect the cost, duration and execution or implementation of the contract, project, or work and examine all instructions, forms, terms, and project requirements in the Bidding Documents.	13
4. Corrupt, Fraudulent, Collusive, and Coercive Practices	13
5. Eligible Bidders	14
6. Origin of Goods	14
7. Subcontracts	15
8. Pre-Bid Conference	15
9. Clarification and Amendment of Bidding Documents	15
10. Documents comprising the Bid: Eligibility and Technical Components	15
11. Documents comprising the Bid: Financial Component	16
12. Bid Prices	16
13. Bid and Payment Currencies	17
14. Bid Security	18
15. Sealing and Marking of Bids	18
16. Deadline for Submission of Bids	18
17. Opening and Preliminary Examination of Bids	19
18. Domestic Preference	19
19. Detailed Evaluation and Comparison of Bids	19
20. Post-Qualification	20
21. Signing of the Contract	21
Section III. Bid Data Sheet	22
Section IV. General Conditions of Contract.....	26
1. Scope of Contract	27
2. Advance Payment and Terms of Payment	27
3. Performance Security	27
4. Inspection and Tests	28
5. Warranty	28
6. Liability of the Supplier	28
Section V. Special Conditions of Contract	29
Section VI. Schedule of Requirements	35

Section VII. Technical Specifications.....41
Section VIII. Checklist of Technical and Financial Documents.....56
MISCELLANEOUS PROVISIONS.....77

Glossary of Acronyms, Terms, and Abbreviations

ABC –Approved Budget for the Contract.

BAC – Bids and Awards Committee.

Bid – A signed offer or proposal to undertake a contract submitted by a bidder in response to and in consonance with the requirements of the bidding documents. Also referred to as *Proposal* and *Tender*.(2016 revised IRR, Section 5[c])

Bidder – Refers to a contractor, manufacturer, supplier, distributor and/or consultant who submits a bid in response to the requirements of the Bidding Documents. (2016 revised IRR, Section 5[d])

Bidding Documents – The documents issued by the Procuring Entity as the bases for bids, furnishing all information necessary for a prospective bidder to prepare a bid for the Goods, Infrastructure Projects, and/or Consulting Services required by the Procuring Entity. (2016 revised IRR, Section 5[e])

BIR – Bureau of Internal Revenue.

BSP – Bangko Sentral ng Pilipinas.

Consulting Services – Refer to services for Infrastructure Projects and other types of projects or activities of the GOP requiring adequate external technical and professional expertise that are beyond the capability and/or capacity of the GOP to undertake such as, but not limited to: (i) advisory and review services; (ii) pre-investment or feasibility studies; (iii) design; (iv) construction supervision; (v) management and related services; and (vi) other technical services or special studies. (2016 revised IRR, Section 5[i])

CDA - Cooperative Development Authority.

Contract – Refers to the agreement entered into between the Procuring Entity and the Supplier or Manufacturer or Distributor or Service Provider for procurement of Goods and Services; Contractor for Procurement of Infrastructure Projects; or Consultant or Consulting Firm for Procurement of Consulting Services; as the case may be, as recorded in the Contract Form signed by the parties, including all attachments and appendices thereto and all documents incorporated by reference therein.

CI – Cost Insurance and Freight.

CIP – Carriage and Insurance Paid.

CPI – Consumer Price Index.

DDP – Refers to the quoted price of the Goods, which means “delivered duty paid.”

DTI – Department of Trade and Industry.

EXW – Ex works.

FCA – “Free Carrier” shipping point.

FOB – “Free on Board” shipping point.

Foreign-funded Procurement or Foreign-Assisted Project–Refers to procurement whose funding source is from a foreign government, foreign or international financing institution as specified in the Treaty or International or Executive Agreement. (2016 revised IRR, Section 5[b]).

Framework Agreement – Refers to a written agreement between a procuring entity and a supplier or service provider that identifies the terms and conditions, under which specific purchases, otherwise known as “Call-Offs,” are made for the duration of the agreement. It is in the nature of an option contract between the procuring entity and the bidder(s) granting the procuring entity the option to either place an order for any of the goods or services identified in the Framework Agreement List or not buy at all, within a minimum period of one (1) year to a maximum period of three (3) years. (GPPB Resolution No. 27-2019)

GFI – Government Financial Institution.

GOCC –Government-owned and/or –controlled corporation.

Goods – Refer to all items, supplies, materials and general support services, except Consulting Services and Infrastructure Projects, which may be needed in the transaction of public businesses or in the pursuit of any government undertaking, project or activity, whether in the nature of equipment, furniture, stationery, materials for construction, or personal property of any kind, including non-personal or contractual services such as the repair and maintenance of equipment and furniture, as well as trucking, hauling, janitorial, security, and related or analogous services, as well as procurement of materials and supplies provided by the Procuring Entity for such services. The term “related” or “analogous services” shall include, but is not limited to, lease or purchase of office space, media advertisements, health maintenance services, and other services essential to the operation of the Procuring Entity. (2016 revised IRR, Section 5[r])

GOP – Government of the Philippines.

GPPB –Government Procurement Policy Board.

INCOTERMS – International Commercial Terms.

Infrastructure Projects – Include the construction, improvement, rehabilitation, demolition, repair, restoration or maintenance of roads and bridges, railways, airports, seaports, communication facilities, civil works components of information technology projects, irrigation, flood control and drainage, water supply, sanitation, sewerage and solid waste management systems, shore protection, energy/power and electrification facilities, national buildings, school buildings, hospital buildings, and other related construction projects of the government. Also referred to as *civil works or works*. (2016 revised IRR, Section 5[u])

LGUs – Local Government Units.

NFCC – Net Financial Contracting Capacity.

NGA – National Government Agency.

PhilGEPS - Philippine Government Electronic Procurement System.

Procurement Project – refers to a specific or identified procurement covering goods, infrastructure project or consulting services. A Procurement Project shall be described, detailed, and scheduled in the Project Procurement Management Plan prepared by the agency which shall be consolidated in the procuring entity's Annual Procurement Plan. (GPPB Circular No. 06-2019 dated 17 July 2019)

PSA – Philippine Statistics Authority.

SEC – Securities and Exchange Commission.

SLCC – Single Largest Completed Contract.

Supplier – refers to a citizen, or any corporate body or commercial company duly organized and registered under the laws where it is established, habitually established in business and engaged in the manufacture or sale of the merchandise or performance of the general services covered by his bid. (Item 3.8 of GPPB Resolution No. 13-2019, dated 23 May 2019). Supplier as used in these Bidding Documents may likewise refer to a distributor, manufacturer, contractor, or consultant.

UN – United Nations

Section I. Invitation to Bid

INVITATION TO BID
FOR THE
SUPPLY AND DELIVERY OF VARIOUS OFFICE SUPPLIES
FOR THE PROCUREMENT SERVICE

PUBLIC BIDDING NO. 20-064-2

FUNDING SOURCE: PROCUREMENT SERVICE FUNDS

1. The *Procurement Service* invites PhilGEPS registered suppliers to bid for the following items in accordance with the provisions of the Revised IRR of R.A. 9184 on the use of the **Approved Guidelines on the use of a Single Year Framework Agreement (Outright Determination of Lowest Calculated and Responsive Bid) under GPPB Resolution No. 27-2019:**

Lot No.	Quantity	Item/Description	Approved Budget for the Contract	Price of Bid Documents	Delivery Period
1	14,820 pieces	Puncher, paper, heavy duty	2,148,900.00	1,000.00	Please refer to Section VI. Schedule of Requirements (Framework Agreement List)
2	103,980 boxes	Staple Wire, standard	2,559,500.00	1,000.00	
3	35,880 pieces	Stapler, standard type	4,843,800.00	1,000.00	

Bidders should have completed, within *five (5) years* prior to the date of submission and receipt of bids, a contract similar to the Project.

2. The summary of the bidding activities is as follows:

Advertisement/Posting of Invitation to Bid	15 December 2020
Issuance and Availability of Bid Documents	15 December 2020
Pre-Bid Conference	22 December 2020; 10:30 AM
Last day of Submission of Written Clarification	23 December 2020
Last day of Issuance of Bid Bulletin	29 December 2020
Deadline for Submission	05 January 2021; 10:00 AM
Opening of Bids	Immediately after the Deadline of Submission of Bids

3. Bidding will be conducted through open competitive bidding procedures using a non-discretionary “pass/fail” criterion as specified in the Implementing Rules and Regulations (IRR) of Republic Act (RA) 9184, otherwise known as the “Government Procurement Reform Act”.
4. Bidding is restricted to Filipino citizens/sole proprietorships, partnerships, or organizations with at least sixty percent (60%) interest or outstanding capital stock belonging to citizens of the Philippines, and to citizens or organizations of a country the laws or regulations of which grant similar rights or privileges to Filipino citizens, pursuant to RA 5183 and subject to Commonwealth Act 138.
5. Interested bidders may obtain further information from the Procurement Service and inspect the Bidding Documents at the address given below during office hours.

A complete set of Bidding Documents may be acquired by interested Bidders from the PS Cashier’s Office and upon payment of a nonrefundable fee in amounts pursuant to the Schedule.

It may also be downloaded free of charge from the website of the Procurement Service – DBM (PS-DBM), provided that Bidders shall pay the nonrefundable fee for the Bidding Documents not later than the submission of their bids.

6. The *Procurement Service* will hold a Pre-Bid Conference on **22 December 2020; 10:30 AM** at the Bidding Room, Conference Room, Procurement Service, Cristobal St., Paco, Manila which shall be open to all interested parties. Pursuant to the Modified Enhanced Community Quarantine and strict implementation of physical distancing due to the pandemic, the scheduled meeting may be accessed thru this link: <https://meet.google.com/win-bsxj-iew> for online access via Google Meet.
7. All Bids must be accompanied by a bid security in any of the acceptable forms and in the amount stated in ITB Clause 18.

Bid opening shall be conducted on **05 January 2021; 10:00 AM** at the Bidding Room, Conference Room, Procurement Service, Cristobal St., Paco, Manila. Pursuant to the Modified Enhanced Community Quarantine and strict implementation of physical distancing due to the pandemic, the scheduled meeting may be accessed thru this link: <https://meet.google.com/met-mdgb-dwj> for online access via Google Meet. Bids will be opened in the presence of the Bidders’ representatives who choose to attend the opening. **Late bids shall not be accepted. Unsealed or unmarked bid envelopes shall also be rejected.**

8. Bidders shall drop their duly accomplished eligibility requirements, technical and financial proposals in two separate sealed envelopes in the designated bid box located at the 2nd Floor of the Procurement Service.

9. The ***Procurement Service*** reserves the right to accept or reject any bid, to annul the bidding process, and to reject all bids at any time prior to contract award, without thereby incurring any liability to the affected bidder or bidders.
10. For further information, please refer to:

Bids and Awards Committee II

Procurement Service

RR Road, Cristobal St., Paco, Manila

8290-6300 loc. 4030

pd6@ps-philgeps.gov.ph; vdisu@ps-philgeps.gov.ph

SIGNATURE REDACTED

PAUL JASPER V. DE GUZMAN

Chairperson, Bids and Awards Committee II

Section II. Instructions to Bidders

1. Scope of Bid

The Procuring Entity, *Procurement Service* wishes to receive Bids for the *Supply and Delivery of Various Office Supplies under a Framework Agreement*, with identification number *Public Bidding No. 20-064-2*.

The Procurement Project (referred to herein as “Project”) is composed of *three (3) Lots*, the details of which are described in Section VII (Technical Specifications).

2. Funding Information

2.1. The GOP through the source of funding as indicated below for *2020* in the amount of *Nine Million Five Hundred Fifty Two Thousand Two Hundred Pesos (₱9,552,200.00)*.

2.2. The source of funding is: *Procurement Service Funds*

3. Bidding Requirements

The Bidding for the Project shall be governed by all the provisions of RA No. 9184 and its 2016 revised IRR, including its Generic Procurement Manuals and associated policies, rules and regulations as the primary source thereof, while the herein clauses shall serve as the secondary source thereof.

Any amendments made to the IRR and other GPPB issuances shall be applicable only to the ongoing posting, advertisement, or **IB** by the BAC through the issuance of a supplemental or bid bulletin.

The Bidder, by the act of submitting its Bid, shall be deemed to have verified and accepted the general requirements of this Project, including other factors that may affect the cost, duration and execution or implementation of the contract, project, or work and examine all instructions, forms, terms, and project requirements in the Bidding Documents.

4. Corrupt, Fraudulent, Collusive, and Coercive Practices

The Procuring Entity, as well as the Bidders and Suppliers, shall observe the highest standard of ethics during the procurement and execution of the contract. They or through an agent shall not engage in corrupt, fraudulent, collusive, coercive, and obstructive practices defined under Annex “I” of the 2016 revised IRR of RA No. 9184 or other integrity violations in competing for the Project.

5. Eligible Bidders

- 5.1. Only Bids of Bidders found to be legally, technically, and financially capable will be evaluated.
- 5.2. Foreign ownership exceeding those allowed under the rules may participate pursuant to:
 - i. When a Treaty or International or Executive Agreement as provided in Section 4 of the RA No. 9184 and its 2016 revised IRR allow foreign bidders to participate;
 - ii. Citizens, corporations, or associations of a country, included in the list issued by the GPPB, the laws or regulations of which grant reciprocal rights or privileges to citizens, corporations, or associations of the Philippines;
 - iii. When the Goods sought to be procured are not available from local suppliers; or
 - iv. When there is a need to prevent situations that defeat competition or restrain trade.
- 5.3. Pursuant to Section 23.4.1.3 of the 2016 revised IRR of RA No.9184, the Bidder shall have an SLCC that is at least one (1) contract similar to the Project the value of which, adjusted to current prices using the PSA's CPI, must be at least equivalent to:

For the procurement of Expendable Supplies: The Bidder must have completed a single contract that is similar to this Project, equivalent to at least twenty-five percent (25%) of the ABC.
- 5.4. The Bidders shall comply with the eligibility criteria under Section 23.4.1 of the 2016 IRR of RA No. 9184.

6. Origin of Goods

There is no restriction on the origin of goods other than those prohibited by a decision of the UN Security Council taken under Chapter VII of the Charter of the UN, subject to Domestic Preference requirements under **ITB** Clause 18.

7. Subcontracts

- 7.1. The Bidder may subcontract portions of the Project to the extent allowed by the Procuring Entity as stated herein, but in no case more than twenty percent (20%) of the Project.

The Procuring Entity has prescribed that: *Subcontracting is not allowed.*

- 7.2. Subcontracting of any portion of the Project does not relieve the Supplier of any liability or obligation under the Contract. The Supplier will be responsible for the acts, defaults, and negligence of any subcontractor, its agents, servants, or workmen as fully as if these were the Supplier's own acts, defaults, or negligence, or those of its agents, servants, or workmen.

8. Pre-Bid Conference

The Procuring Entity will hold a pre-bid conference for this Project on the specified date and time and either at its physical address and/or through videoconferencing/webcasting as indicated in paragraph 6 of the **IB**.

9. Clarification and Amendment of Bidding Documents

Prospective bidders may request for clarification on and/or interpretation of any part of the Bidding Documents. Such requests must be in writing and received by the Procuring Entity, either at its given address or through electronic mail indicated in the **IB**, *at least ten (10) calendar days* before the deadline set for the submission and receipt of Bids.

10. Documents comprising the Bid: Eligibility and Technical Components

- 10.1. The first envelope shall contain the eligibility and technical documents of the Bid as specified in **Section VIII (Checklist of Technical and Financial Documents)**.
- 10.2. The Bidder's SLCC as indicated in **ITB** Clause 5.3 should have been completed within *five (5) years* prior to the deadline for the submission and receipt of bids.
- 10.3. If the eligibility requirements or statements, the bids, and all other documents for submission to the BAC are in foreign language other than English, it must be accompanied by a translation in English, which shall be authenticated by the appropriate Philippine foreign service establishment, post, or the equivalent office having jurisdiction over the foreign bidder's affairs in the Philippines. Similar to the required authentication above, for Contracting

Parties to the Apostille Convention, only the translated documents shall be authenticated through an apostille pursuant to GPPB Resolution No. 13-2019 dated 23 May 2019. The English translation shall govern, for purposes of interpretation of the bid.

11. Documents comprising the Bid: Financial Component

- 11.1. The second bid envelope shall contain the financial documents for the Bid as specified in **Section VIII (Checklist of Technical and Financial Documents)**.
- 11.2. If the Bidder claims preference as a Domestic Bidder or Domestic Entity, a certification issued by DTI shall be provided by the Bidder in accordance with Section 43.1.3 of the 2016 revised IRR of RA No. 9184.
- 11.3. Any bid exceeding the ABC indicated in paragraph 1 of the **IB** shall not be accepted.
- 11.4. For Foreign-funded Procurement, a ceiling may be applied to bid prices provided the conditions are met under Section 31.2 of the 2016 revised IRR of RA No. 9184.
- 11.5. Financial proposals for single or multi-year Framework Agreement shall be submitted before the deadline of submission of bids as prescribed in the **IB**. For multi-year Framework Agreement, evaluation of the financial proposal during this stage is for purposes of determining eligibility and whether or not such financial proposal is within the ABC.

12. Bid Prices

- 12.1. Prices indicated on the Price Schedule shall be entered separately in the following manner:
 - a. For Goods offered from within the Procuring Entity's country:
 - i. The price of the Goods quoted EXW (ex-works, ex-factory, ex-warehouse, ex-showroom, or off-the-shelf, as applicable);
 - ii. The cost of all customs duties and sales and other taxes already paid or payable;
 - iii. The cost of transportation, insurance, and other costs incidental to delivery of the Goods to their final destination; and

- iv. The price of other (incidental) services, if any, listed in e.
 - b. For Goods offered from abroad:
 - i. Unless otherwise stated in the **BDS**, the price of the Goods shall be quoted delivered duty paid (DDP) with the place of destination in the Philippines as specified in the **BDS**. In quoting the price, the Bidder shall be free to use transportation through carriers registered in any eligible country. Similarly, the Bidder may obtain insurance services from any eligible source country.
 - ii. The price of other (incidental) services, if any, as listed in **Section VII (Technical Specifications)**.
- 12.2. For Framework Agreement, the following should also apply in addition to Clause 12.1:
- a. For a single year Framework Agreement, the prices quoted by the Bidder shall be fixed during the Bidder's performance of the contract and not subject to variation or escalation on any account. Price schedules required under Clause 12.1 shall be submitted with the bidding documents.
 - b. For a multi-year Framework Agreement, the prices quoted by the Bidder during submission of eligibility documents shall be the ceiling and the price quoted during mini-competition must not exceed the initial price offer. The price quoted during call for mini-competition shall be fixed during the Bidder's performance of that Call-off and not subject to variation or escalation on any account. Price schedules required under Clause 12.1 shall be submitted with the bidding documents.

13. Bid and Payment Currencies

- 13.1. For Goods that the Bidder will supply from outside the Philippines, the bid prices may be quoted in the local currency or tradeable currency accepted by the BSP at the discretion of the Bidder. However, for purposes of bid evaluation, Bids denominated in foreign currencies, shall be converted to Philippine currency based on the exchange rate as published in the BSP reference rate bulletin on the day of the bid opening.
- 13.2. Payment of the contract price shall be made in: ***Philippine Pesos***.

14. Bid Security

- 14.1. The Bidder shall submit a Bid Securing Declaration¹ or any form of Bid Security in the amount indicated in the **BDS**, which shall be not less than the percentage of the ABC in accordance with the schedule in the **BDS**.
- 14.2. The Bid and bid security shall be valid until *05 May 2021 (120 calendar days from the opening of bids)*. Any Bid not accompanied by an acceptable bid security shall be rejected by the Procuring Entity as non-responsive.
- 14.3. In the case of Framework Agreement, other than the grounds for forfeiture under the 2016 revised IRR, the bid security may also be forfeited if the successful bidder fails to sign the Framework Agreement, or fails to furnish the performance security or performance securing declaration. Without prejudice on its forfeiture, bid securities shall be returned only after the posting of performance security or performance securing declaration, as the case may be, by the winning Bidder or compliant Bidders and the signing of the Framework Agreement.

15. Sealing and Marking of Bids

Each Bidder shall submit one copy of the first and second components of its Bid.

The Procuring Entity may request additional hard copies and/or electronic copies of the Bid. However, failure of the Bidders to comply with the said request shall not be a ground for disqualification.

If the Procuring Entity allows the submission of bids through online submission or any other electronic means, the Bidder shall submit an electronic copy of its Bid, which must be digitally signed. An electronic copy that cannot be opened or is corrupted shall be considered non-responsive and, thus, automatically disqualified.

16. Deadline for Submission of Bids

- 16.1. The Bidders shall submit on the specified date and time and either at its physical address or through online submission as indicated in paragraph 7 of the **IB**.

¹ In the case of Framework Agreement, the undertaking shall refer to entering into contract with the Procuring Entity and furnishing of the performance security or the performance securing declaration within ten (10) calendar days from receipt of Notice to Execute Framework Agreement.

- 16.2. For multi-year Framework Agreement, the submission of bids shall be for the initial evaluation of their technical and financial eligibility. Thereafter, those declared eligible during the said initial eligibility evaluation and entered into a Framework Agreement with the Procuring Entity shall submit anew their best financial offer at the address and on or before the date and time indicated in the Call for each mini-competition.

17. Opening and Preliminary Examination of Bids

- 17.1. The BAC shall open the Bids in public at the time, on the date, and at the place specified in paragraph 9 of the **IB**. The Bidders' representatives who are present shall sign a register evidencing their attendance. In case videoconferencing, webcasting or other similar technologies will be used, attendance of participants shall likewise be recorded by the BAC Secretariat.

In case the Bids cannot be opened as scheduled due to justifiable reasons, the rescheduling requirements under Section 29 of the 2016 revised IRR of RA No. 9184 shall prevail.

- 17.2. The preliminary examination of bids shall be governed by Section 30 of the 2016 revised IRR of RA No. 9184.

18. Domestic Preference

- 18.1. The Procuring Entity will grant a margin of preference for the purpose of comparison of Bids in accordance with Section 43.1.2 of the 2016 revised IRR of RA No. 9184.
- 18.2. For multi-year Framework Agreement, determination of margin of preference shall be conducted every call for Mini-Competition.

19. Detailed Evaluation and Comparison of Bids

- 19.1. The Procuring BAC shall immediately conduct a detailed evaluation of all Bids rated "*passed*," using non-discretionary pass/fail criteria. The BAC shall consider the conditions in the evaluation of Bids under Section 32.2 of the 2016 revised IRR of RA No. 9184.
 - a. In the case of single-year Framework Agreement, the Lowest Calculated Bid shall be determined outright after the detailed evaluation;
 - b. For multi-year Framework Agreement, the determination of the eligibility and the compliance of bidders with the technical and financial aspects of

the projects shall be initially made by the BAC, in accordance with Item 7.4.2 of the Guidelines on the Use of Framework Agreement.

- 19.2. If the Project allows partial bids, bidders may submit a proposal on any of the lots or items, and evaluation will be undertaken on a per lot or item basis, as the case may be. In this case, the Bid Security as required by **ITB** Clause 15 shall be submitted for each lot or item separately.
- 19.3. The descriptions of the lots or items shall be indicated in **Section VII (Technical Specifications)**, although the ABCs of these lots or items are indicated in the **BDS** for purposes of the NFCC computation pursuant to Section 23.4.2.6 of the 2016 revised IRR of RA No. 9184. The NFCC must be sufficient for the total of the ABCs for all the lots or items participated in by the prospective Bidder.
- 19.4. The Project shall be awarded as follows: *One Project having several items grouped into several lots, which shall be awarded as separate contracts per lot.*
- 19.5. Except for bidders submitting a committed Line of Credit from a Universal or Commercial Bank in lieu of its NFCC computation, all Bids must include the NFCC computation pursuant to Section 23.4.1.4 of the 2016 revised IRR of RA No. 9184, which must be sufficient for the total of the ABCs for all the lots or items participated in by the prospective Bidder. For bidders submitting the committed Line of Credit, it must be at least equal to ten percent (10%) of the ABCs for all the lots or items participated in by the prospective Bidder.

20. Post-Qualification

- 20.1. For multi-year Framework Agreement, all bidders initially determined to be eligible and financially compliant shall be subject to initial post-qualification. The BAC shall then recommend the execution of a Framework Agreement among all eligible, technically and financially compliant bidders and the Procuring Entity and shall be issued by HoPE a Notice to Execute Framework Agreement. The determination of the Lowest Calculated Bid (LCB) shall not be performed by the BAC until a Mini-Competition is conducted among the bidders who executed a Framework Agreement. When a Call for Mini-Competition is made, the BAC shall allow the bidders to submit their best financial proposals on such pre-scheduled date, time and place to determine the bidder with the LCB.
- 20.2. Within a non-extendible period of five (5) calendar days from receipt by the Bidder of the notice from the BAC that it submitted the Lowest Calculated Bid, or in the case of multi-year Framework Agreement, that it is one of the

eligible bidders who have submitted bids that are found to be technically and financially compliant, the Bidder shall submit its latest income and business tax returns filed and paid through the BIR Electronic Filing and Payment System (eFPS) and other appropriate licenses and permits required by law and stated in the **BDS**. For every mini-competition in Framework Agreement, the LCB shall likewise submit the required documents for final Post Qualification.

21. Signing of the Contract

- 21.1. The documents required in Section 37.2 of the 2016 revised IRR of RA No. 9184 shall form part of the Contract. Additional Contract documents are indicated in the **BDS**.
- 21.2. At the same time as the Procuring Entity notifies the successful Bidder that its bid has been accepted, the Procuring Entity shall send the Framework Agreement Form to the Bidder, which contract has been provided in the Bidding Documents, incorporating therein all agreements between the parties.
- 21.3. Within ten (10) calendar days from receipt of the Notice to Execute Framework Agreement with the Procuring Entity, the successful Bidder or its duly authorized representative shall formally enter into a Framework Agreement with the procuring entity for an amount of One Peso to be paid to the procuring entity as a consideration for the option granted by the procuring entity to procure the items in the Framework Agreement List when the need arises.
- 21.4. The Procuring Entity shall enter into a Framework Agreement with the successful Bidder within the same ten (10) calendar day period provided that all the documentary requirements are complied with.
- 21.5. The following documents shall form part of the Framework Agreement:
 - a. Framework Agreement Form;
 - b. Bidding Documents;
 - c. Call-offs;
 - d. Winning bidder's bid, including the Technical and Financial Proposals, and all other documents/statements submitted (*e.g.*, bidder's response to request for clarifications on the bid), including corrections to the bid, if any, resulting from the Procuring Entity's bid evaluation;
 - e. Performance Security or Performance Securing Declaration, as the case may be;
 - f. Notice to Execute Framework Agreement; and
 - g. Other contract documents that may be required by existing laws and/or specified in the **BDS**.

Section III. Bid Data Sheet

Bid Data Sheet

ITB Clause																						
5.3	<p>For this purpose, contracts similar to the Project shall be:</p> <p style="margin-left: 40px;">a. <i>Those in Section VIII. Annex “K” but may include other contracts similar to those classified as Office Supplies.</i></p> <p style="margin-left: 40px;">b. completed within <i>five (5) years</i> prior to the deadline for the submission and receipt of bids.</p>																					
7.1	<i>Subcontracting is not allowed.</i>																					
12	<p>The price of the Goods shall be quoted DDP <i>PS Warehouse, PS Complex, RR Road Cristobal St., Paco, Manila; and End-User Agencies within Metro Manila, Antipolo, Imus, Cavite and Pampanga</i> or the applicable International Commercial Terms (INCOTERMS) for this Project.</p>																					
14.1	<p>The bid security shall be in the form of a Bid Securing Declaration, or any of the following forms and amounts:</p> <table border="1" style="width: 100%; border-collapse: collapse; margin-top: 10px;"> <thead> <tr> <th style="text-align: center;">Lot No.</th> <th style="text-align: center;">Item/Description</th> <th style="text-align: center;">Amount Cash, Cashier’s / Manager’s Check, Bank Draft/ Guarantee/ Irrevocable Letter of Credit (2%)</th> <th style="text-align: center;">Surety bond callable upon demand issued by a surety or insurance company duly certified by the Insurance Commission (5%)</th> <th style="text-align: center;">Bid Securing Declaration (Pursuant to GPPB Resolution No. 03-2012)</th> </tr> </thead> <tbody> <tr> <td style="text-align: center;">1</td> <td style="text-align: center;">Puncher, paper, heavy duty</td> <td style="text-align: center;">₱ 42,978.00</td> <td style="text-align: center;">₱ 107,445.00</td> <td rowspan="3" style="text-align: center; vertical-align: middle;">Please see Section VIII attached as Annex “H”</td> </tr> <tr> <td style="text-align: center;">2</td> <td style="text-align: center;">Staple Wire, standard</td> <td style="text-align: center;">₱ 51,190.00</td> <td style="text-align: center;">₱ 127,975.00</td> </tr> <tr> <td style="text-align: center;">3</td> <td style="text-align: center;">Stapler, standard type</td> <td style="text-align: center;">₱ 96,876.00</td> <td style="text-align: center;">₱ 242,190.00</td> </tr> </tbody> </table> <p style="margin-top: 10px;">The bid security in the form of cashier’s/manager’s check shall be payable to PROCUREMENT SERVICE.</p>				Lot No.	Item/Description	Amount Cash, Cashier’s / Manager’s Check, Bank Draft/ Guarantee/ Irrevocable Letter of Credit (2%)	Surety bond callable upon demand issued by a surety or insurance company duly certified by the Insurance Commission (5%)	Bid Securing Declaration (Pursuant to GPPB Resolution No. 03-2012)	1	Puncher, paper, heavy duty	₱ 42,978.00	₱ 107,445.00	Please see Section VIII attached as Annex “H”	2	Staple Wire, standard	₱ 51,190.00	₱ 127,975.00	3	Stapler, standard type	₱ 96,876.00	₱ 242,190.00
Lot No.	Item/Description	Amount Cash, Cashier’s / Manager’s Check, Bank Draft/ Guarantee/ Irrevocable Letter of Credit (2%)	Surety bond callable upon demand issued by a surety or insurance company duly certified by the Insurance Commission (5%)	Bid Securing Declaration (Pursuant to GPPB Resolution No. 03-2012)																		
1	Puncher, paper, heavy duty	₱ 42,978.00	₱ 107,445.00	Please see Section VIII attached as Annex “H”																		
2	Staple Wire, standard	₱ 51,190.00	₱ 127,975.00																			
3	Stapler, standard type	₱ 96,876.00	₱ 242,190.00																			
19.3	<p>The NFCC computation, if applicable, must be sufficient for all the lots or contracts to be awarded to the Bidder:</p>																					

	Lot No.	Quantity	Item/Description	Approved Budget for the Contract
	1	14,820 pieces	Puncher, paper, heavy duty	₱ 2,148,900.00
	2	103,980 boxes	Staple Wire, standard	₱ 2,559,500.00
	3	35,880 pieces	Stapler, standard type	₱ 4,843,800.00
20.2	<p>For purposes of Post-qualification the following document(s) shall be required:</p> <ol style="list-style-type: none"> Income Tax Returns for year 2019 (BIR Form 1701 or 1702). Latest Value Added Tax Returns (Forms 2550M and 2550Q) or Percentage Tax Returns (Form 2551M). For this requirement, covering the months June to November 2020. <i>The income tax and business tax returns stated above should have been filed through the Electronic Filing and Payment System (EFPS).</i> Proof of completion of the single largest contract as identified in the Statement of Single Largest Contract, which shall be copy of any verifiable document(s) such as but not limited to the following: (a) Contract/s or Purchase Order/s; (b) corresponding Sales Invoice/s; (c) Official Receipt/Cash Receipt/Collection Receipt; and (d) Certificate of Satisfactory Completion. Submission of pieces of evidence as proof of compliance with the bidder's actual offer, if applicable. In the column "Bidder's Compliance", the bidder must state "comply" against each of the individual parameters of each specification corresponding to performance parameter of equipment offered. Statement of "comply" must be supported by evidence in a bidders bid and cross-referenced to that evidence. Evidence shall be in the form of manufacturer's or distributor's un-amended sales literature, unconditional statements or specification and compliance issued by the manufacturer or distributor, samples, independent test data etc., as appropriate. Valid and updated PhilGEPS Certificate of Registration (Platinum Membership), in the event that the PhilGEPS Certificate and the annexes submitted during Opening of Bids is not updated. 			

	<p>Bidders with overdue deliveries as of the date of opening of bids are not allowed to participate in the bidding for same items.</p> <p><i>N.B. Documents submitted during post-qualification as part of post-qualification documents must be certified by the authorized representative to be true copy/ies from the original.</i></p>
21.2	No further instructions.
21.5(g)	<p>The awardee must submit a soft copy (JPEG or PNG format, Picture- 640 x 480 pixel with white or plain background) of the color picture of the product/s upon receipt of the Notice to Execute Framework Agreement (NEFA).</p> <p>Please email to: pd10@ps-philgeps.gov.ph</p>

Section IV. General Conditions of Contract

1. **Scope of Contract**

This Contract shall include all such items, although not specifically mentioned, that can be reasonably inferred as being required for its completion as if such items were expressly mentioned herein. All the provisions of RA No. 9184 and its 2016 revised IRR, including the Generic Procurement Manual, and associated issuances, constitute the primary source for the terms and conditions of the Contract, and thus, applicable in contract implementation. Herein clauses shall serve as the secondary source for the terms and conditions of the Contract.

This is without prejudice to Sections 74.1 and 74.2 of the 2016 revised IRR of RA No. 9184 allowing the GPPB to amend the IRR, which shall be applied to all procurement activities, the advertisement, posting, or invitation of which were issued after the effectivity of the said amendment.

Additional requirements for the completion of this Contract shall be provided in the **Special Conditions of Contract (SCC)**.

2. **Advance Payment and Terms of Payment**

- 2.1. Advance payment of the contract amount is provided under Annex “D” of the revised 2016 IRR of RA No. 9184.
- 2.2. The Procuring Entity is allowed to determine the terms of payment on the partial or staggered delivery of the Goods procured, provided such partial payment shall correspond to the value of the goods delivered and accepted in accordance with prevailing accounting and auditing rules and regulations. The terms of payment are indicated in the **SCC**.
- 2.3. For a single-year Framework Agreement, prices charged by the Supplier for Goods delivered and/or services performed under a Call-Off shall not vary from the prices quoted by the Supplier in its bid.
- 2.4. For multi-year Framework Agreement, prices charged by the Supplier for Goods delivered and/or services performed under a Call-Off shall not vary from the prices quoted by the Supplier during conduct of Mini-Competition.

3. **Performance Security**

Within ten (10) calendar days from receipt of the Notice to Execute Framework Agreement (NEFA) by the Bidder from the Procuring Entity but in no case later than prior to the signing of the Contract by both parties, the successful Bidder shall furnish the performance security in any of the forms prescribed in Section 39 of the 2016

revised IRR of RA No. 9184. *In the case of Framework Agreement*, the Bidder may opt to furnish the performance security or a Performance Securing Declaration as defined under the Guidelines on the Use of Framework Agreement.

4. Inspection and Tests

The Procuring Entity or its representative shall have the right to inspect and/or to test the Goods to confirm their conformity to the Project or Framework Agreement/ specifications at no extra cost to the Procuring Entity in accordance with the Generic Procurement Manual. In addition to tests in the **SCC, Section IV (Technical Specifications)** shall specify what inspections and/or tests the Procuring Entity requires, and where they are to be conducted. The Procuring Entity shall notify the Supplier in writing, in a timely manner, of the identity of any representatives retained for these purposes.

All reasonable facilities and assistance for the inspection and testing of Goods, including access to drawings and production data, shall be provided by the Supplier to the authorized inspectors at no charge to the Procuring Entity.

5. Warranty

5.1 In order to assure that manufacturing defects shall be corrected by the Supplier, a warranty shall be required from the Supplier as provided under Section 62.1 of the 2016 revised IRR of RA No. 9184.

5.2 The Procuring Entity shall promptly notify the Supplier in writing of any claims arising under this warranty. Upon receipt of such notice, the Supplier shall, repair or replace the defective Goods or parts thereof without cost to the Procuring Entity, pursuant to the Generic Procurement Manual.

6. Liability of the Supplier

The Supplier's liability under this Contract shall be as provided by the laws of the Republic of the Philippines.

If the Supplier is a joint venture, all partners to the joint venture shall be jointly and severally liable to the Procuring Entity.

Section V. Special Conditions of Contract

Special Conditions of Contract

GCC Clause	
1	<p>The Project Sites are:</p> <p><i>PS Warehouse, PS Complex, RR Road Cristobal St., Paco, Manila; and End-User Agencies within Metro Manila, Antipolo, Imus, Cavite and Pampanga</i></p> <p>Delivery and Documents –</p> <p>For purposes of the Contract, “EXW,” “FOB,” “FCA,” “CIF,” “CIP,” “DDP” and other trade terms used to describe the obligations of the parties shall have the meanings assigned to them by the current edition of INCOTERMS published by the International Chamber of Commerce, Paris. The Delivery terms of this Contract shall be as follows:</p> <p><i>[For Goods supplied from abroad, state:]</i> “The delivery terms applicable to the Contract are DDP delivered <i>[indicate place of destination]</i>. In accordance with INCOTERMS.”</p> <p><i>[For Goods supplied from within the Philippines, state:]</i> “The delivery terms applicable to this Contract are delivered <i>[indicate place of destination]</i>. Risk and title will pass from the Supplier to the Procuring Entity upon receipt and final acceptance of the Goods at their final destination.”</p> <p>Delivery of the Goods shall be made by the Supplier in accordance with the terms specified in Section VI (Schedule of Requirements).</p> <p>For purposes of this Clause the Procuring Entity’s Representative at the Project Site is <i>Ms. Catherine Anne Mirabel, OIC-Chief WALD.</i></p> <p>Incidental Services –</p> <p>The Supplier is required to provide all of the following services, including additional services, if any, specified in Section VI. Schedule of Requirements:</p> <ol style="list-style-type: none"> a. performance or supervision of on-site assembly and/or start-up of the supplied Goods; b. furnishing of tools required for assembly and/or maintenance of the supplied Goods; c. furnishing of a detailed operations and maintenance manual for each appropriate unit of the supplied Goods;

- d. performance or supervision or maintenance and/or repair of the supplied Goods, for a period of time agreed by the parties, provided that this service shall not relieve the Supplier of any warranty obligations under this Contract; and
- e. training of the Procuring Entity's personnel, at the Supplier's plant and/or on-site, in assembly, start-up, operation, maintenance, and/or repair of the supplied Goods.

The Contract price for the Goods shall include the prices charged by the Supplier for incidental services and shall not exceed the prevailing rates charged to other parties by the Supplier for similar services.

Spare Parts –

The Supplier is required to provide all of the following materials, notifications, and information pertaining to spare parts manufactured or distributed by the Supplier:

- a. such spare parts as the Procuring Entity may elect to purchase from the Supplier, provided that this election shall not relieve the Supplier of any warranty obligations under this Contract; and
- b. in the event of termination of production of the spare parts:
 - i. advance notification to the Procuring Entity of the pending termination, in sufficient time to permit the Procuring Entity to procure needed requirements; and
 - ii. following such termination, furnishing at no cost to the Procuring Entity, the blueprints, drawings, and specifications of the spare parts, if requested.

The spare parts and other components required are listed in **Section VI (Schedule of Requirements)** and the cost thereof are included in the contract price.

The Supplier shall carry sufficient inventories to assure ex-stock supply of consumable spare parts or components for the Goods for a period of **Three (3) months**.

Spare parts or components shall be supplied as promptly as possible, but in any case, within **Three (3) months** of placing the order.

Packaging –

The Supplier shall provide such packaging of the Goods as is required to prevent their damage or deterioration during transit to their final destination, as indicated in this Contract. The packaging shall be sufficient to withstand, without limitation, rough handling during transit and exposure to extreme temperatures, salt and precipitation during transit, and open storage. Packaging case size and weights shall take into consideration, where appropriate, the remoteness of the Goods' final destination and the absence of heavy handling facilities at all points in transit.

The packaging, marking, and documentation within and outside the packages shall comply strictly with such special requirements as shall be expressly provided for in the Contract, including additional requirements, if any, specified below, and in any subsequent instructions ordered by the Procuring Entity.

The outer packaging must be clearly marked on at least four (4) sides as follows:

- Name of the Procuring Entity
- Name of the Supplier
- Contract Description
- Final Destination
- Gross weight
- Any special lifting instructions
- Any special handling instructions
- Any relevant HAZCHEM classifications

A packaging list identifying the contents and quantities of the package is to be placed on an accessible point of the outer packaging if practical. If not practical the packaging list is to be placed inside the outer packaging but outside the secondary packaging.

Transportation –

Where the Supplier is required under Contract to deliver the Goods CIF, CIP, or DDP, transport of the Goods to the port of destination or such other named place of destination in the Philippines, as shall be specified in this Contract, shall be arranged and paid for by the Supplier, and the cost thereof shall be included in the Contract Price.

	<p>Where the Supplier is required under this Contract to transport the Goods to a specified place of destination within the Philippines, defined as the Project Site, transport to such place of destination in the Philippines, including insurance and storage, as shall be specified in this Contract, shall be arranged by the Supplier, and related costs shall be included in the contract price.</p> <p>Where the Supplier is required under Contract to deliver the Goods CIF, CIP or DDP, Goods are to be transported on carriers of Philippine registry. In the event that no carrier of Philippine registry is available, Goods may be shipped by a carrier which is not of Philippine registry provided that the Supplier obtains and presents to the Procuring Entity certification to this effect from the nearest Philippine consulate to the port of dispatch. In the event that carriers of Philippine registry are available but their schedule delays the Supplier in its performance of this Contract the period from when the Goods were first ready for shipment and the actual date of shipment the period of delay will be considered force majeure.</p> <p>The Procuring Entity accepts no liability for the damage of Goods during transit other than those prescribed by INCOTERMS for DDP deliveries. In the case of Goods supplied from within the Philippines or supplied by domestic Suppliers risk and title will not be deemed to have passed to the Procuring Entity until their receipt and final acceptance at the final destination.</p> <p>Intellectual Property Rights –</p> <p>The Supplier shall indemnify the Procuring Entity against all third-party claims of infringement of patent, trademark, or industrial design rights arising from use of the Goods or any part thereof.</p>										
2.2	<i>Progress payment shall be made after acceptance of each delivery.</i>										
4	<p>The inspections and tests that will be conducted shall be in accordance with Section VII. Technical Specifications. A visual comparison will be made with the approved sample for purposes of consistency in the physical appearance and color.</p> <table border="1" data-bbox="357 1655 1402 1948"> <thead> <tr> <th data-bbox="357 1655 453 1948">Lot No.</th> <th data-bbox="453 1655 735 1948">Quantity</th> <th data-bbox="735 1655 983 1948">Item/ Description</th> <th data-bbox="983 1655 1174 1948">Additional quantity for every batch of delivery for acceptance test</th> <th data-bbox="1174 1655 1402 1948">Testing Center</th> </tr> </thead> <tbody> <tr> <td> </td> <td> </td> <td> </td> <td> </td> <td> </td> </tr> </tbody> </table>	Lot No.	Quantity	Item/ Description	Additional quantity for every batch of delivery for acceptance test	Testing Center					
Lot No.	Quantity	Item/ Description	Additional quantity for every batch of delivery for acceptance test	Testing Center							

	1	14,820 pieces	Puncher, paper, heavy duty	One (1) piece	In-house Testing
	2	103,980 boxes	Staple Wire, standard	One (1) box	
	3	35,880 pieces	Stapler, standard type	One (1) piece	
<p><u>Note:</u></p> <ul style="list-style-type: none"> - <i>Continuous random post acceptance testing shall be conducted on deliveries nationwide.</i> - <i>Supplier shall retribute to the PS all payments otherwise previously made for the deliveries later found to be rampantly defective.</i> 					

Section VI. Schedule of Requirements

***Schedule of Requirements
(Framework Agreement)***

LOT NO.	ITEM DESCRIPTION	TOTAL QUANTITY	DELIVERY PERIOD
1	Puncher, paper, heavy duty	14,820 pieces	1 st tranche: 7,680 pieces within seven (7) calendar days upon receipt of the call-off 2 nd tranche: 7,140 pieces - within seven (7) calendar days upon receipt of the call-off

Note: Suppliers shall maintain two (2) months revolving stocks at all times.

I hereby commit to deliver the required quality and quantities upon receipt of the Call-Off as indicated above.

Name of Company	Signature Over Printed Name of Authorized Representative	Date
-----------------	---	------

***Schedule of Requirements
(Framework Agreement)***

LOT NO.	ITEM DESCRIPTION	TOTAL QUANTITY	DELIVERY PERIOD
2	Staple Wire, standard	103,980 boxes	1 st tranche: 54,000 boxes - within seven (7) calendar days upon receipt of the call-off 2 nd tranche: 49,980 boxes - within seven (7) calendar days upon receipt of the call-off

Note: Suppliers shall maintain two (2) months revolving stocks at all times.

I hereby commit to deliver the required quality and quantities upon receipt of the Call-Off as indicated above.

Name of Company	Signature Over Printed Name of Authorized Representative	Date
-----------------	---	------

***Schedule of Requirements
(Framework Agreement)***

LOT NO.	ITEM DESCRIPTION	TOTAL QUANTITY	DELIVERY PERIOD
3	Stapler, standard type	35,880 pieces	1 st tranche: 11,960 pieces - within seven (7) calendar days upon receipt of the call-off 2 nd tranche: 11,960 pieces - within seven (7) calendar days upon receipt of the call-off 3 rd tranche: 11,960 pieces - within seven (7) calendar days upon receipt of the call-off

Note: Suppliers shall maintain two (2) months revolving stocks at all times.

I hereby commit to deliver the required quality and quantities upon receipt of the Call-Off as indicated above.

Name of Company	Signature Over Printed Name of Authorized Representative	Date
-----------------	---	------

SUBMISSION OF SAMPLES/DEMO UNITS

All bidders shall submit the following samples/demo units to the Bids and Awards Committee (BAC) thru the Technical Working Group (TWG) **on or before the deadline of bid submission** for evaluation and testing purposes:

LOT NO.	ITEM/DESCRIPTION	REQUIREMENTS	TESTING CENTER
1	Puncher, paper, heavy duty	One (1) piece conforms with Section VII. Technical Specifications required under this bidding documents	In-house Testing
2	Staple Wire, standard	One (1) box conforms with Section VII. Technical Specifications required under this bidding documents	
3	Stapler, standard type	Three (3) pieces conforms with Section VII. Technical Specifications required under this bidding documents	

For Lot 1 & 3:

Suppliers are required to include one (1) ream of A4-sized paper, 70gsm, upon receipt of Notice of Lowest Calculated Bid for the purpose of product testing during the Post-Qualification Stage.

For Lot 2:

Supplier is required to include twenty (20) sheets of newsprints, upon receipt of Notice of Lowest Calculated Bid for the purpose of product testing during the Post-Qualification Stage.

All deliveries shall be subject to Acceptance Test Requirements pursuant to GCC Clause 16 in which case the awardee-supplier shall include additional quantity in every batch of delivery for acceptance and testing purposes.

Evaluation of sample/demo unit during post-qualification stage shall be conducted by the BAC, through Technical Working Group using in-house tests or government laboratory testing center. If government laboratory testing center does not have the capability or no available machine to conduct the tests, government accredited private laboratory testing center will be used.

Section VII. Technical Specifications

LOT NO. 1	:	Puncher, paper, heavy duty
QUANTITY	:	14,820 pieces
APPROVED BUDGET PER PIECE	:	₱ 145.00
APPROVED BUDGET FOR THE CONTRACT	:	₱ 2,148,900.00

AGENCY SPECIFICATIONS	BIDDER'S STATEMENT OF COMPLIANCE ¹
<p>Puncher, paper, heavy duty</p> <p>Conforms to the attached Technical Specifications PS STANDARD NO. OS 013:2016 UNSPSC Code No. 44101602-PU-P01 Dated: 25 November 2016</p> <p>*For Packaging and Marking/Labeling Requirements based from TSRC Resolution No. 19-005 dated November 20, 2019. Please see attached Annexes and in reference to Consumer Act RA 7394 Article 77 and 119 –</p>	<p>Brand:</p>

We commit to deliver the goods under the new packaging and consistent with the physical appearance and color of the sample submitted as required by the Procurement Service.

I hereby certify that the statement of compliance to the foregoing technical specifications are true and correct, otherwise, if found to be false either during bid evaluation or post-qualification, the same shall give rise to automatic disqualification of our bid.

Name of Company	Signature Over Printed Name of Authorized Representative	Date
-----------------	---	------

¹ Bidders must state here either “**Comply**” or “**Not Comply**” against each of the individual parameters of each Specification stating the corresponding performance parameter of the equipment offered. Statements of “Comply” or “Not Comply” must be supported by evidence in a Bidders Bid and cross-referenced to that evidence. Evidence shall be in the form of manufacturer’s un-amended sales literature, unconditional statements of specification and compliance issued by the manufacturer, samples, independent test data etc., as appropriate. A statement that is not supported by evidence or is subsequently found to be contradicted by the evidence presented will render the Bid under evaluation liable for rejection. A statement either in the Bidder's statement of compliance or the supporting evidence that is found to be false either during Bid evaluation, post-qualification or the execution of the Contract may be regarded as fraudulent and render the Bidder or supplier liable for prosecution subject to the applicable laws and issuances.

Technical Requirements for
PUNCHER, PAPER, HEAVY DUTY

PRODUCT SPECIFICATIONS

- Punching Capacity: 30 sheets of 70gsm Multipurpose Paper
- With two hole guide
- Diameter of Hole: 7mm (approx)
- Construction / Structure
 - The operating lever, base and frame shall be connected to each other and be capable of smooth repetitive operation
 - Easy insertion of paper.
 - The distance between the two holes shall be 70mm (±0.5mm) center-to-center.
 - The punching depth shall be 12mm (±1mm)
 - The puncher shall be provided with a lever lock
 - The receptacle base shall not chip off, break, crack, warp or the like
- As per attached illustration showing the parts of the paper puncher, however, design may vary

EVIDENCE AND VERIFICATION

- Shall conform with the performance requirements for heavy duty paper puncher under PNS 1987:2012:
 - Durability
 - Cutting Sharpness
 - Impact Resistance
- Cutting Sharpness Test (Annex C)
 - A sheet of paper shall be punched five (5) times in normal service condition
- Punching Quality Test (Annex D)
 - Thirty (30) sheets of 70gsm Multipurpose paper shall be inserted in the insertion aperture and punched 300 times in normal service condition, after which the Annex C Test shall be performed.
- Impact Resistance Test (Annex E)
 - From a height of 1 meter, the specimen puncher shall be dropped one (1) time with its base kept parallel to the floor surface
- One (1) piece shall be submitted to the BAC during opening of bids for verification of the product specifications.
- Marking: Shall conform with the Consumer Act of the Phil. (RA 7394)

PACKAGING

- Twenty-four (24) pieces per carton, in individual box

MARKING/LABELING

- Shall conform with the Consumer Act of the Phil. (RA 7394)





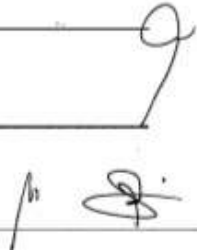

REFERENCES

- PNS 1987:2012

ILLUSTRATION

PNS 1987:2012

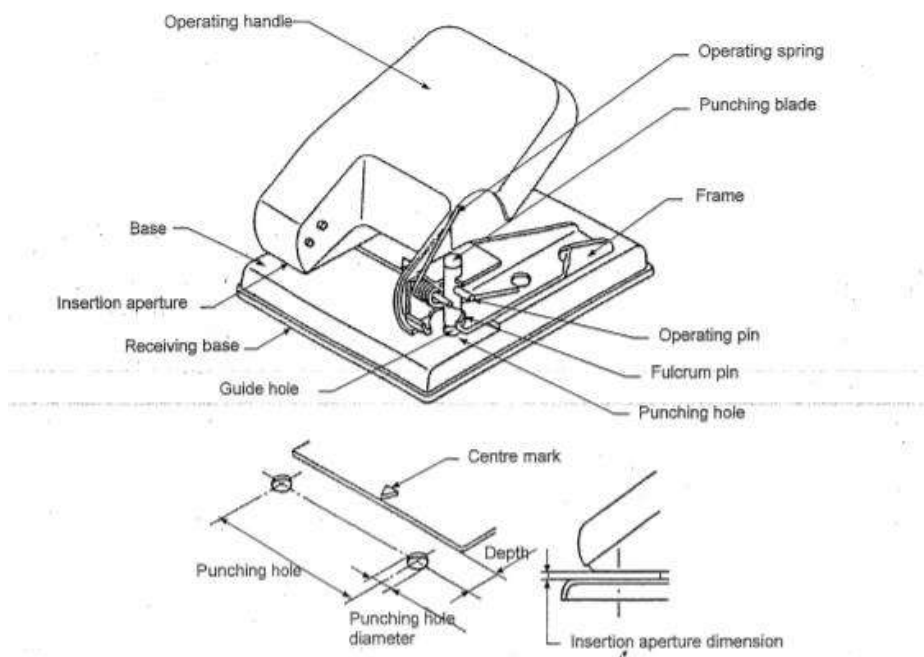

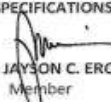

Figure 1 (Figure shows one example)

RECOMMENDED FOR REVIEW

TECHNICAL SPECIFICATIONS REVIEW TEAM



Engr. PABLO ROMAN C. ANDRES
Member



Mr. JAYSON C. ERQUIZA
Member



Mr. JERONIEL B. GALIT
Member

Engr. ANTONIO B. HERMIDA, JR.
Member

Ms. AMELITA F. HERNANDEZ
Member

Engr. JAIME M. NAVARRETE, JR.
Member



Mr. MERVIN JAN D. TANQUINTIC
Member

Engr. EDWARD R. SADDI
Team Leader

OCTOBER 28, 2016
Puncher, Paper, Heavy Duty

RECOMMENDED FOR APPROVAL

TECHNICAL SPECIFICATIONS REVIEW COMMITTEE

Atty. VINCENT G. CAÑARES
OIC, BAC Support Division

Engr. JULIETTA M. LOZANO
Chief, Purchasing Division



Ms. ROSA MARIA M. CLEMENTE
Senior BAC Chairperson
OIC-Deputy Executive Director V

Ms. FLORIDA G. ARIAS
OIC- Operations Group

APPROVAL

Approved:

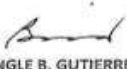
Disapproved:

Ms. BINGLE B. GUTIERREZ
Executive Director

Effectivity date: November 25, 2016

LOT NO. 2	:	Staple Wire, standard
QUANTITY	:	103,980 boxes
APPROVED BUDGET PER BOX	:	₱ 25.00
APPROVED BUDGET FOR THE CONTRACT	:	₱ 2,559,500.00

AGENCY SPECIFICATIONS	BIDDER'S STATEMENT OF COMPLIANCE ¹
<p>Staple Wire, standard</p> <p>Conforms to the attached Technical Specifications PS STANDARD NO. OS 015:2016 UNSPSC Code No. 31151804-SW-S01 Dated: 25 November 2016</p> <p>*For Packaging and Marking/Labeling Requirements based from TSRC Resolution No. 19-005 dated November 20, 2019. Please see attached Annexes and in reference to Consumer Act RA 7394 Article 77 and 119</p>	<p>Brand:</p>

We commit to deliver the goods under the new packaging and consistent with the physical appearance and color of the sample submitted as required by the Procurement Service.

I hereby certify that the statement of compliance to the foregoing technical specifications are true and correct, otherwise, if found to be false either during bid evaluation or post-qualification, the same shall give rise to automatic disqualification of our bid.

Name of Company	Signature Over Printed Name of Authorized Representative	Date
-----------------	---	------

¹ Bidders must state here either “**Comply**” or “**Not Comply**” against each of the individual parameters of each Specification stating the corresponding performance parameter of the equipment offered. Statements of “Comply” or “Not Comply” must be supported by evidence in a Bidders Bid and cross-referenced to that evidence. Evidence shall be in the form of manufacturer’s un-amended sales literature, unconditional statements of specification and compliance issued by the manufacturer, samples, independent test data etc., as appropriate. A statement that is not supported by evidence or is subsequently found to be contradicted by the evidence presented will render the Bid under evaluation liable for rejection. A statement either in the Bidder's statement of compliance or the supporting evidence that is found to be false either during Bid evaluation, post-qualification or the execution of the Contract may be regarded as fraudulent and render the Bidder or supplier liable for prosecution subject to the applicable laws and issuances.

Technical Requirements for
STAPLE WIRE, Standard

PRODUCT SPECIFICATIONS

- 5000 wires per box
- Made of Steel Wire coated with zinc, copper or any equivalent anti-corrosion material
- Dimensions, in mm: (See Fig. 1)
 - Width (W): $12.70 +0.15\text{mm}/-0.20\text{mm}$
 - Leg Length (L): $6.00 +0.50\text{mm}/-0.20\text{mm}$
 - Thickness (D): $0.40 \pm 0.05\text{mm}$
 - Width (E): $0.50 \pm 0.05\text{mm}$
- Number of Wires per Strip: 100 (min)
- The staples shall be preformed and cemented together in strip form one behind the other
- The staples shall have parallel legs and at right angles to the crown which shall permit easy exit of the staples without clogging and jamming the stapler
- Each end of the staples shall have either blunt or chisel point ends
- Staples shall be free from burrs and sharp or rough edges and other defects which might affect the appearance or serviceability of the leg

EVIDENCE AND VERIFICATION

- Shall conform with the required performance tests
 - The staple cement shall be applied smoothly and shall adhere to each staple sufficiently to ensure its exit from the vertical chute without accumulation, clogging and jamming stapler
 - The temper and carbon content of the wire shall permit penetration and clinching to a firm seat without buckling or fracturing of the crown or leg
 - The staples shall be removed without fracture from any type of staple remover
 - For penetration performance, all staples shall penetrate and clinch to 20 sheets of newsprints without buckling or fracturing of the crown or leg and shall not show any malformation when tested. (Annex A of PNS 1162:1994)
 - The Electric stapler shall be used for testing purposes of sample/s
 - No rust shall develop on the staples when tested in accordance with Corrosion Resistance Test. (Annex B of PNS 1162:199)

Allowable defects: 10 defects (maximum) per trial

A *J*

T

B

9
S

- One (1) box shall be submitted to the BAC during *opening of bids* for verification of the product specifications.

PACKAGING

- In a box (5000 wires per box)
One Hundred (100) boxes per carton.

REFERENCES

- *PNS 1162:2008*

ILLUSTRATION

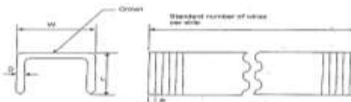

Figure 1 - Staples

[Handwritten signatures and initials]

RECOMMENDED FOR REVIEW

TECHNICAL SPECIFICATIONS REVIEW TEAM

- | | | |
|---|---|---|
| <i>[Signature]</i>
Engr. PABLO ROMAN C. ANDRES
Member | <i>[Signature]</i>
Mr. JAYSON C. ERQUIZA
Member | <i>[Signature]</i>
Mr. JEROME B. GALIT
Member |
| Engr. ANTONIO B. HERMIDA, JR.
Member | Ms. AMELIA F. HERNANDEZ
Member | Engr. JAIME N. NAVARRETE, JR.
Member |
| Mr. MERVIN IAN D. TANQUINTIC
Member | Engr. EDWARD R. SADDI
Team Leader | |

OCTOBER 28, 2016
Staple Wire, Standard

RECOMMENDED FOR APPROVAL

TECHNICAL SPECIFICATIONS REVIEW COMMITTEE

- | | |
|---|---|
| <i>[Signature]</i>
Atty. VINCENT G. CAÑARES
OIC, BAC Support Division | <i>[Signature]</i>
Engr. JULIA M. LOZANO
Chief, Purchasing Division |
| Ms. ROSA MARIA M. CLEMENTE
Senior BAC Chairperson
OIC-Deputy Executive Director V | Ms. FLORIDA G. ARIAS
OIC-Operations Group |

APPROVAL

Approved:
Disapproved:

[Signature]
Ms. SINGLE B. GUTIERREZ
Executive Director

Effectivity date: *November 25, 2016*

LOT NO. 3	:	Stapler, standard type
QUANTITY	:	35,880 pieces
APPROVED BUDGET PER PIECE	:	₱ 135.00
APPROVED BUDGET FOR THE CONTRACT	:	₱ 4,843,800.00

AGENCY SPECIFICATIONS	BIDDER'S STATEMENT OF COMPLIANCE¹
<p>Stapler, standard type</p> <p>Conforms to the attached Technical Specifications PS STANDARD NO. OS 017:2014 UNSPSC Code No. 44121615-ST-S01 Dated: 06 February 2017</p> <p>*For Packaging and Marking/Labeling Requirements based from TSRC Resolution No. 19-005 dated November 20, 2019. Please see attached Annexes and in reference to Consumer Act RA 7394 Article 77 and 119</p>	<p>Brand:</p>

We commit to deliver the goods under the new packaging and consistent with the physical appearance and color of the sample submitted as required by the Procurement Service.

I hereby certify that the statement of compliance to the foregoing technical specifications are true and correct, otherwise, if found to be false either during bid evaluation or post-qualification, the same shall give rise to automatic disqualification of our bid.

Name of Company	Signature Over Printed Name of Authorized Representative	Date
-----------------	---	------

¹ Bidders must state here either “**Comply**” or “**Not Comply**” against each of the individual parameters of each Specification stating the corresponding performance parameter of the equipment offered. Statements of “Comply” or “Not Comply” must be supported by evidence in a Bidders Bid and cross-referenced to that evidence. Evidence shall be in the form of manufacturer’s un-amended sales literature, unconditional statements of specification and compliance issued by the manufacturer, samples, independent test data etc., as appropriate. A statement that is not supported by evidence or is subsequently found to be contradicted by the evidence presented will render the Bid under evaluation liable for rejection. A statement either in the Bidder's statement of compliance or the supporting evidence that is found to be false either during Bid evaluation, post-qualification or the execution of the Contract may be regarded as fraudulent and render the Bidder or supplier liable for prosecution subject to the applicable laws and issuances.

Technical Requirements for
STAPLER, standard type

PRODUCT SPECIFICATIONS

- Loading Capacity: 200 staples (min)
- One time binding capacity of 2-20 sheets multi-purpose paper (70gsm)
- Staple pusher shall be a metal piece and not spring
- Construction/Structure:
 - The handle, base and frame shall be connected respectively and be smooth in repetitive actuation
 - Loading of the staple wire in the staple magazine shall be easy
 - The stapler shall be constructed that the staple wire will not jam or drop out during stapling
 - The base shall be constructed that it is equipped with clincher block having the guide groove aligned with the driver blade so that it can bind properly and easily
 - The driver blade shall be able to push out and drive the received staple wire without deformation
 - Each part shall have rigidity in meeting the performance of the stapler
 - As per attached illustration showing the parts of the stapler, however, design may vary
 - Shall conform with the required performance tests:
- Packaging: Eight (8) pieces per pack, in individual box
- Reference: PNS 1561:2008

EVIDENCE AND VERIFICATION

Performance Test:

1. One (1) Time Binding Capacity

1.1 Procedure:

- 1.1.1 Prepares 2-20 sheets of 70gsm dry Multi-Purpose Paper forms at least 1.5" x 1.5" in dimension and numbered accordingly as to the no. of sheets
- 1.1.2 Using an approved sample staple wire, conduct one (1) time binding on all sheets in chronological order, starting with 2 sheets up to 20 sheets.
- 1.1.3 Conduct the test on the three (3) samples of stapler

[Handwritten signatures and marks]

1.2 Standards:

- 1.2.1 Must be able to bind all sheets without buckling
- 1.2.2 The legs of the staple wires shall be symmetrical and the ends of the legs shall be fastened to the back surface of the paper
- 1.2.3 Allowable Defect: Zero (0) for each sample
- 1.2.4 Two (2) samples must pass the test

2. Binding Performance Test.

2.1 Procedure:

- 2.1.1 Prepare ten (10) sets of 14 sheets 70gsm dry Multi-Purpose Paper forms at least 1.25" x 8" in dimension and numbered accordingly as to the no. of sets
- 2.1.2 Using an approved sample staple wire, conduct lacing (10x binding) on each set starting from the left to right motion of binding. A minimum interval of 30 seconds per lacing shall be provided to accommodate resting.
- 2.1.3 Conduct the test on the three (3) samples of stapler.

2.2 Standard:

- 2.2.1 Must be able to bind all sheets without buckling.
- 2.2.2 The legs of the staple wires shall be symmetrical and the ends of the legs shall be tightly fastened to the back surface of the paper.
- 2.2.3 Allowable Defect: Five (5) defects only for each sample.
- 2.2.4 Two (2) samples must pass the test.

Testing Procedure:

- a. The test shall be performed with the stapler resting on the table top
- b. Taking reference on the clincher block, the stapler shall be placed within 3 to 5 inches from the edge of the table.
- c. Single hand vertical pressure shall be applied on the stapler and to be performed seated

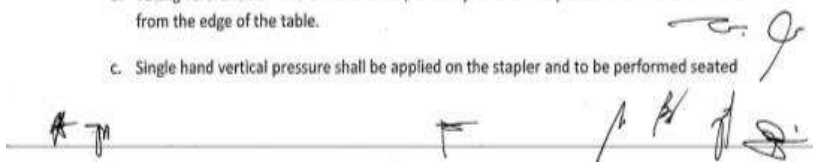

- d. Staple wire to be used for the test shall be randomly picked from the Procurement Service's current inventory and shall be replaced by the bidder
 - e. Conduct of one (1) time binding capacity shall be performed without interference from the non-dominant hand,
 - f. Interpretation of clinching/tightly fastened defect shall be as follows;
 - Buckled wire is a defect;
 - All ends of the legs should be symmetrical (properly curved with respect to the clinching block), straightened leg is a defect;
 - End of the legs that are not touching the surface of the paper shall be allowed as long as symmetry is achieved.
 - g. The bidders' authorized representatives shall conduct the performance test. However, if the authorized representatives disagree to conduct the test themselves, then their right to question the testing procedure and the test results shall be waived.
- Three (3) pieces shall be submitted to the BAC during opening of bids for verification of the product specifications.

PACKAGING

- Eight (8) pieces per pack, in individual box.

MARKING/LABELING

- *Shall conform with the Consumer Act of the Phil. (RA 7394)*

REFERENCES

- PNS: 1561-2008



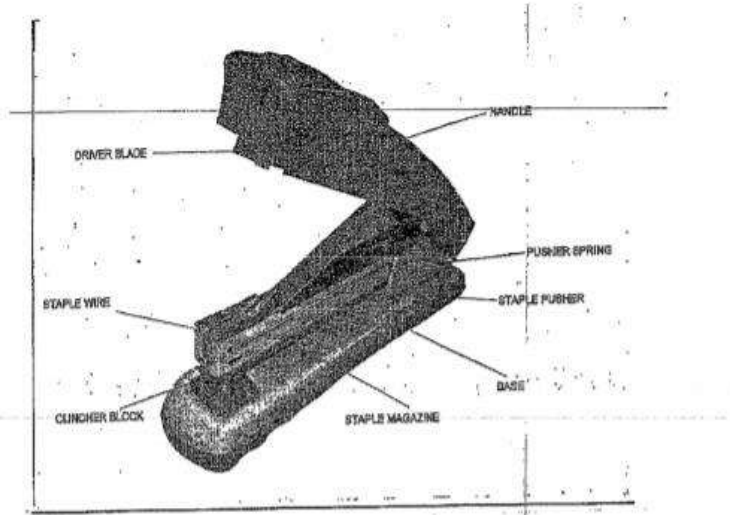

Handwritten signatures and initials are present at the bottom of the page. On the left, there is a signature that appears to be 'J. M.'. In the center, there is a simple vertical line with a horizontal bar at the top, resembling a checkmark or a signature. On the right, there is a more complex signature with a large loop at the top and several strokes below it.

ILLUSTRATION



RECOMMENDED FOR REVIEW

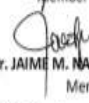



TECHNICAL SPECIFICATIONS REVIEW TEAM

 Engr. PABLO ROMAN C. ANDRES Member	Mr. JAYSON C. ERQUIZA Member	 Mr. JERNIMEL B. GALIT Member
 Engr. ANTONIO B. HERMIDA, JR. Member	Ms. AMELITA F. HERNANDEZ Member	 Engr. JAIME M. NAVARRETE, JR. Member
 Mr. MERVIN-IAN D. TANQUINTIC Member		 Engr. EDWARD R. SADDI Team Leader

February 6, 2017
STAPLER, Standard Type

RECOMMENDED FOR APPROVAL

TECHNICAL SPECIFICATIONS REVIEW COMMITTEE

 Atty. VHINCENT G. CAÑARES OIC, BAC Support Division	 Engr. JULIETA M. LOZANO Chief, Purchasing Division
 Ms. ROSA MARIA M. CLEMENTE Senior BAC Chairperson OIC-Deputy Executive Director V	 Ms. FLERIDA G. ARIAS OIC- Operations Group

APPROVAL

Approved:
Disapproved:

Ms. BINGLE B. GUTIERREZ
Executive Director

Effectivity date: 06 FEB 2017

Product: *STAPLER,
Standard type*

**Additional Requirement on Packaging and Marking/Labeling
Based on TSRC Resolution No. TSRC 19-005**

PACKAGING:

On each pack or box or ream or item, the following should be legibly imprinted or stickered with non-removable or permanent sticker or label that is binding and with residue and tearing. If removed:

- The name and logo of the Procurement Service
- The address and contact details of the Procurement Service
- A statement which states that the item is “Government Property” “Not for Redistribution of For Sale”
- Procured by Procurement Service-DBM

(Complete details of the sticker will be given to the responsive bidder)

On each corrugated carton or outer box or outer packaging, the following should be legibly imprinted or stickered with non-removable or permanent sticker or label that binding and with residue and tearing, if removed.

- The name and logo of the Procurement Service
- The address and contact details of the Procurement Service
- A statement which states that the item is “Government Property” “Not for Redistribution or For Sale”
- Procured by Procurement Service-DBM

(Complete details of the sticker will be given to the responsive bidder)

Size or dimension of the label will depend on the size of the individual packaging.

The location where to place the label will be determined during the Pre-bid Conference.

MARKING/LABELING:

Shall conform to the following minimum Marking and Labeling requirement:

1. Its correct and registered trade name or brand name;
2. Its duly registered trademark;
3. Its duly registered business name
4. The address of the manufacturer, importer, repacker of the consumer products in the Philippines;
5. Its general make or active ingredients;
6. The net quality of contents, in terms of weight, measure or numerical count rounded to at least the nearest tenths in the metric system;
7. Country of the manufacturer, **if imported;**
8. If a consumer product is manufactured, refilled or repacked under license from a principal, the label shall so state the fact.

***Section VIII. Checklist of Technical and
Financial Documents***

Checklist of Technical and Financial Documents

I. TECHNICAL COMPONENT ENVELOPE

Class “A” Documents

Legal Documents

- (a) Valid PhilGEPS Registration Certificate (Platinum Membership) (all pages);
or
- (b) Registration certificate from Securities and Exchange Commission (SEC), Department of Trade and Industry (DTI) for sole proprietorship, or Cooperative Development Authority (CDA) for cooperatives or its equivalent document,
and
- (c) Mayor’s or Business permit issued by the city or municipality where the principal place of business of the prospective bidder is located, or the equivalent document for Exclusive Economic Zones or Areas;
and
- (d) Tax clearance per E.O. No. 398, s. 2005, as finally reviewed and approved by the Bureau of Internal Revenue (BIR).

Technical Documents

- (e) Statement of the prospective bidder of all its ongoing government and private contracts, including contracts awarded but not yet started, if any, whether similar or not similar in nature and complexity to the contract to be bid; **and**
- (f) Statement of the bidder’s Single Largest Completed Contract (SLCC) similar to the contract to be bid, except under conditions provided for in Sections 23.4.1.3 and 23.4.2.4 of the 2016 revised IRR of RA No. 9184, within the relevant period as provided in the Bidding Documents; **and**
- (g) Original copy of Bid Security. If in the form of a Surety Bond, submit also a certification issued by the Insurance Commission;
or
Original copy of Notarized Bid Securing Declaration; **and**
- (h) Conformity with the Technical Specifications, which may include production/**delivery schedule**, manpower requirements, and/or after-sales/parts, if applicable; **and**
- (i) Original duly signed Omnibus Sworn Statement (OSS);
and if applicable, Original Notarized Secretary’s Certificate in case of a corporation, partnership, or cooperative; or Original Special Power of Attorney of all members of the joint venture giving full power and authority to its officer to sign the OSS and do acts to represent the Bidder.

Financial Documents

- (j) The Supplier's audited financial statements, showing, among others, the Supplier's total and current assets and liabilities, stamped "received" by the BIR or its duly accredited and authorized institutions, for the preceding calendar year which should not be earlier than two (2) years from the date of bid submission; **and**
- (k) The prospective bidder's computation of Net Financial Contracting Capacity (NFCC) which must be at least equal to the ABC to be bid, calculated as follows:

NFCC = [(Current assets minus current liabilities) (15)] minus the value of all outstanding or uncompleted portions of the projects under ongoing contracts, including awarded contracts yet to be started, coinciding with the contract to be bid.

or

A committed Line of Credit from a Universal or Commercial Bank in lieu of its NFCC computation.

If the prospective bidder opts to submit a committed Line of Credit, it must be at least equal to ten percent (10%) of the ABC to be bid. If issued by a foreign universal or commercial bank, it shall be confirmed or authenticated by a local universal or commercial bank.

Class "B" Documents

- (l) If applicable, a duly signed joint venture agreement (JVA) in case the joint venture is already in existence;
- or**
- duly notarized statements from all the potential joint venture partners stating that they will enter into and abide by the provisions of the JVA in the instance that the bid is successful.

II. FINANCIAL COMPONENT ENVELOPE

- (m) Original of duly signed and accomplished Financial Bid Form; **and**
- (n) Original of duly signed and accomplished Price Schedule(s).

Bid Form

Date: _____
 Invitation to Bid No: **PB No. 20-064-2**

*To: DBM-PS BAC II Chairperson
 Procurement Service
 PS Complex, RR Road
 Cristobal St., Paco, Manila*

Gentlemen and/or Ladies:

Having examined the Bidding Documents including Bid Bulletin Numbers [____], the receipt of which is hereby duly acknowledged, we, the undersigned, offer to ***Supply and Deliver of Various Office Supplies for the Procurement Service*** in conformity with the said Bidding Documents.

Lot No.	Qty/Unit	ITEMS/ DESCRIPTION	UNIT PRICE	TOTAL PRICE
1	14,820 pieces	Puncher, paper, heavy duty		
2	103,980 boxes	Staple Wire, standard		
3	35,880 pieces	Stapler, standard type		

TOTAL PRICE IN WORDS:

Lot 1: _____

Lot 2: _____

Lot 3: _____

We undertake, if our Bid is accepted, to deliver the goods in accordance with the delivery schedule specified in the Section VI. Schedule of Requirements.

If our Bid is accepted, we undertake to provide a performance security in the form, amounts, and within the times specified in the Bidding Documents.

We agree to abide by this Bid for the Bid Validity Period specified in BDS provision for **ITB** Clause **14.2** and it shall remain binding upon us and may be accepted at any time before the expiration of that period.

Until a formal Contract is prepared and executed, this Bid, together with your written acceptance thereof and your Notice to Execute Framework Agreement (NEFA), shall be binding upon us.

We understand that you are not bound to accept the Lowest Calculated Bid or any Bid you may receive.

We certify/confirm that we comply with the eligibility requirements as per **ITB** Clause 5 of the Bidding Documents.

I/We likewise certify/confirm that the undersigned, *[for sole proprietorships, insert]*: as the owner and sole proprietor or authorized representative of *[Name of Bidder]*, has the full power and authority to participate, submit the bid, and to sign and execute the ensuing contract, on the latter's behalf for the *[Name/Title of the Project.]*

Or;

I/We likewise certify/confirm that the undersigned, *[for partnerships, corporations, cooperatives, or joint ventures, insert]*: is granted full power and authority by the *[Name of Bidder]*, to participate, submit the bid and to sign and execute the ensuing contract on the latter's behalf for *[Name/Title of the Project.]*

We acknowledge that failure to sign each and every page of this Bid Form, including the attached Schedule of Prices, shall be a ground for the rejection of our bid.

Dated this _____ day of _____ 20_____.

[signature]

[in the capacity of]

Duly authorized to sign Bid for and on behalf of _____

Schedule of Prices for Goods Offered From Abroad

Name of Bidder: _____ PB No. **20-064-2** Page ___ of ___

1	2	3	4	5	6	7	8	9
Item	Description	Country of origin	Quantity	Unit price CIF port of entry (specify port) or CIP named place (specify border point or place of destination)	Total CIF or CIP price per item (col. 4 x 5)	Unit Price Delivered Duty Unpaid (DDU)	Unit price Delivered Duty Paid (DDP)	Total Price delivered DDP (col 4 x 8)

[signature]

[in the capacity of]

Duly authorized to sign Bid for and on behalf of _____

Schedule of Prices For Goods Offered From Within the Philippines

Name of Bidder: _____ PB No. **20-064-2** Page ___ of ___

1	2	3	4	5	6	7	8	9	10
Item	Description	Country of origin	Quantity	Unit price EXW per item	Transportation and Insurance and all other costs incidental to delivery, per item	Sales and other taxes payable if Contract is awarded, per item	Cost of Incidental Services, if applicable, per item	Total Price, per unit (col 5+6+7+8)	Total Price delivered Final Destination (col 9) x (col 4)

[signature]

[in the capacity of]

Duly authorized to sign Bid for and on behalf of _____

Omnibus Sworn Statement (Revised)

[shall be submitted with the Bid]

REPUBLIC OF THE PHILIPPINES)
CITY/MUNICIPALITY OF _____) S.S.

AFFIDAVIT

I, [Name of Affiant], of legal age, [Civil Status], [Nationality], and residing at [Address of Affiant], after having been duly sworn in accordance with law, do hereby depose and state that:

1. *[Select one, delete the other:]*

[If a sole proprietorship:] I am the sole proprietor or authorized representative of [Name of Bidder] with office address at [address of Bidder];

[If a partnership, corporation, cooperative, or joint venture:] I am the duly authorized and designated representative of [Name of Bidder] with office address at [address of Bidder];

2. *[Select one, delete the other:]*

[If a sole proprietorship:] As the owner and sole proprietor, or authorized representative of [Name of Bidder], I have full power and authority to do, execute and perform any and all acts necessary to participate, submit the bid, and to sign and execute the ensuing contract for [Name of the Project] of the [Name of the Procuring Entity], as shown in the attached duly notarized Special Power of Attorney;

[If a partnership, corporation, cooperative, or joint venture:] I am granted full power and authority to do, execute and perform any and all acts necessary to participate, submit the bid, and to sign and execute the ensuing contract for [Name of the Project] of the [Name of the Procuring Entity], as shown in the attached [state title of attached document showing proof of authorization (e.g., duly notarized Secretary’s Certificate, Board/Partnership Resolution, or Special Power of Attorney, whichever is applicable)];

3. [Name of Bidder] is not “blacklisted” or barred from bidding by the Government of the Philippines or any of its agencies, offices, corporations, or Local Government Units, foreign government/foreign or international financing institution whose blacklisting rules have been recognized by the Government Procurement Policy Board, **by itself or by relation, membership, association, affiliation, or controlling interest with another blacklisted person or entity as defined and provided for in the Uniform Guidelines**

on Blacklisting;

4. Each of the documents submitted in satisfaction of the bidding requirements is an authentic copy of the original, complete, and all statements and information provided therein are true and correct;
5. [Name of Bidder] is authorizing the Head of the Procuring Entity or its duly authorized representative(s) to verify all the documents submitted;
6. *[Select one, delete the rest:]*

[If a sole proprietorship:] The owner or sole proprietor is not related to the Head of the Procuring Entity, members of the Bids and Awards Committee (BAC), the Technical Working Group, and the BAC Secretariat, the head of the Project Management Office or the end-user unit, and the project consultants by consanguinity or affinity up to the third civil degree;

[If a partnership or cooperative:] None of the officers and members of [Name of Bidder] is related to the Head of the Procuring Entity, members of the Bids and Awards Committee (BAC), the Technical Working Group, and the BAC Secretariat, the head of the Project Management Office or the end-user unit, and the project consultants by consanguinity or affinity up to the third civil degree;

[If a corporation or joint venture:] None of the officers, directors, and controlling stockholders of [Name of Bidder] is related to the Head of the Procuring Entity, members of the Bids and Awards Committee (BAC), the Technical Working Group, and the BAC Secretariat, the head of the Project Management Office or the end-user unit, and the project consultants by consanguinity or affinity up to the third civil degree;

7. [Name of Bidder] complies with existing labor laws and standards;
8. [Name of Bidder] is aware of and has undertaken the responsibilities as a Bidder in compliance with the Philippine Bidding Documents, which includes:
 - a. Carefully examining all of the Bidding Documents;
 - b. Acknowledging all conditions, local or otherwise, affecting the implementation of the Contract;
 - c. Making an estimate of the facilities available and needed for the contract to be bid, if any; and
 - d. Inquiring or securing Supplemental/Bid Bulletin(s) issued for the [Name of the Project].

9. *[Name of Bidder]* did not give or pay directly or indirectly, any commission, amount, fee, or any form of consideration, pecuniary or otherwise, to any person or official, personnel or representative of the government in relation to any procurement project or activity;

10. In case advance payment was made or given, failure to perform or deliver any of the obligations and undertakings in the contract shall be sufficient grounds to constitute criminal liability for Swindling (Estafa) or the commission of fraud with unfaithfulness or abuse of confidence through misappropriating or converting any payment received by a person or entity under an obligation involving the duty to deliver certain goods or services, to the prejudice of the public and the government of the Philippines pursuant to Article 315 of Act No. 3815 s. 1930, as amended, or the Revised Penal Code;

11. *[Name of Bidder]* hereby assigns the following contact number/s and e-mail address/es as the official telephone/fax number and contact reference of the company where the PS BAC and PS notices may be transmitted.

Telephone No/s.: _____
 Fax No/s.: _____
 E-mail Add/s.: _____
 Mobile No.: _____

It is understood that notices/s transmitted in any of the above-stated telephone/fax numbers and/or e-mail address/es are deemed received as of its transmittal and the reckoning period for the reglementary periods stated in the bidding documents and the 2016 revised Implementing Rules and Regulations of Republic Act No. 9184 shall commence from receipt thereof.

IN WITNESS WHEREOF, I have hereunto set my hand this ___ day of ___, 20__ at _____, Philippines.

 Bidder's Representative/Authorized Signatory

SUBSCRIBED AND SWORN to before me this ___ day of [month] [year] at [place of execution], Philippines. Affiant/s known to me, and known to be the same person/s in the exhibited [insert type of government identification card used*], with his/her photograph and signature appearing thereon, with no. _____ issued on _____ at _____.

Witness my hand and seal this ___ day of [month] [year].

NAME OF NOTARY PUBLIC

Serial No. of Commission _____

Notary Public for _____ until _____

Roll of Attorney's No. _____

PTR No. _____ [date issued], [place issued]

IBP No. _____ [date issued], [place issued]

Doc. No. _____

Page No. _____

Book No. _____

Series of _____.

**The identification card shall be at least one of those acceptable proofs of identity as identified under the provisions of the 2004 Rules on Notarial Practice.*

“Sec. 12. Competent Evidence of Identity – The phrase “competent evidence of identity” refers to the identification of an individual based on:

At least one current identification document issued by an official agency bearing the photograph and signature of the individual, such as but not limited to, passport, driver’s license, Professional Regulations Commission ID, National Bureau of Investigation clearance, police clearance, postal ID, voter’s ID, Barangay certification, Government Service and Insurance System (GSIS) e-card, Social Security System (SSS) card, Philhealth card, senior citizen card, Overseas Workers Welfare Administration (OWWA) ID, OFW ID, seaman’s book, alien certificate of registration/immigrant certificate of registration, government office ID, certification from the National Council for the Welfare of Disabled Persons (NCWDP), Department of Social Welfare and Development (DSWD) certification;

The Board Resolution or Secretary’s Certificate referring to the said Board Resolution designating the bidder’s authorized representative and signatory need not specifically indicate the particular project where such authority is given provided that the said authority covers activities by PS.

Statement of Single Largest Completed Contract Similar to the Contract to be Bid

This is to certify that _____ (company) _____ has the following completed contracts for the past *five (5) years*.

Date of the Contract	Contracting Party	Name of Contract	Kind of Goods Sold	Amount of Contract	Date of Delivery/ End-user's Acceptance	Date of Official Receipt	Bidder is A) Manufacturer B) Supplier C) Distributor

Name and Signature of
Authorized Representative

Date

***Instructions:**

- a) Cut-off date as of:
 - (i) **Up to the day before the deadline of submission of bids.**
- b) **In the column under "Dates", indicate the dates of Delivery/ End-user's Acceptance and Official Receipt.**
- c) **"Name of Contract". Indicate here the Nature/ Scope of the Contract for the Procuring Entity to determine the relevance of the entry with the Procurement at hand. Example: "Supply and Delivery of Various Office Supplies "**

Statement of: (i) Ongoing Contracts and; (ii) Awarded But Not Yet Started Contracts

This is to certify that _____ (company) _____ has the following ongoing and awarded but not yet started contracts:

Date of the Contract	Contracting Party	Name of Contract	Kind of Goods Sold	Amount of Contract	Value of Outstanding Contracts	Bidder is A) Manufacturer B) Supplier C) Distributor

Name and Signature of
Authorized Representative

Date

*Instructions:

- a) State all ongoing contracts including those awarded but not yet started (government and private contracts which may be similar or not similar to the project called for bidding) as of:
 - i. **The day before the deadline of** submission of bids.
- b) If there is no ongoing contract including awarded but not yet started as of the aforementioned period, state none or equivalent term.
- c) The total amount of the ongoing and awarded but not yet started contracts should be consistent with those used in the Net Financial Contracting Capacity (NFCC) in case an NFCC is submitted as an eligibility document.
- d) **"Name of Contract". Indicate here the Nature/ Scope of the Contract for easier tracking of the entries/ representations. Example:**
"Supply and Delivery of Various Office Supplies "

**2020 Procurement Service Framework Agreement for the
Supply and Delivery of [Project]**

NEFA

**Framework Agreement
For the [Title of Project]**

KNOW ALL MEN BY THESE PRESENTS:

This Agreement made and entered into this ____ day of _____ 2020, by and between:

PROCUREMENT SERVICE – DEPARTMENT OF BUDGET AND MANAGEMENT, a government agency duly organized and existing under the laws of the Republic of the Philippines having its principal office at PS Complex, Cristobal Street, Paco, Manila, represented by **LLOYD CHRISTOPHER A. LAO, Undersecretary, OIC-Executive Director**, hereinafter referred to “PS”;

and

[COMPANY NAME] a corporation duly organized and existing under the laws of the Republic of the Philippines and having its principal office at [Address], represented by [NAME], [Position] hereinafter referred to as the “Supplier”;

WITNESSETH, that:

WHEREAS, the **PROCURING ENTITY**, decided to use Framework Agreement on its procurement project _____;

WHEREAS, this Agreement is for the option to purchase the goods determined to be necessary and desirable to address and satisfy the needs of **PS** as the central source of commonly used supplies and equipment of the Philippine Government, but by its nature, use or characteristic, the quantity and exact time of need cannot be accurately pre-determined, viz:

Lot No.	Item	Maximum Qty/Unit	Unit Price	Total Price

WHEREAS, PS has the option to purchase the items provided in the Framework Agreement List, attached and made an integral part of this Agreement as provided in Article I, on a date and time to be determined in the Call-Off to be issued for such purpose by **PS**; and

WHEREAS, the Supplier which passed the eligibility screening conducted by **PS**, shall maintain and update the eligibility requirements during the period of this Agreement and shall honor all obligations under this Framework Agreement.

NOW, THEREFORE, the parties hereby agree as follows:

Article I
GENERAL CONSIDERATIONS

1. This Framework Agreement is an option contract. **PS** is given the option to either purchase the identified items in the Framework Agreement or not to purchase at all. The discretion to exercise the option falls solely with **PS** as the Procuring Entity. The **Supplier** may not require or demand for the latter to purchase the items in the Framework Agreement List.
2. In this Framework Agreement, words and expressions shall have the same meanings as are respectively assigned to them in the Conditions of Contract as reflected in the Bid Documents attending the procurement and made an integral part of this Agreement;
3. The following documents shall be deemed to form and be read and construed as part of this Agreement:
 - a. the Supplier's Bid, including the Technical and Financial Proposals, and all other documents/statements submitted (e.g. bidder's response to clarifications on the bid), including corrections to the bid resulting from the Procuring Entity's bid evaluation;
 - b. the Framework Agreement List and the Technical Specifications;
 - c. the General Conditions of Contract;
 - d. the Special Conditions of Contract;
 - e. the Bid Documents, including the Supplemental Bid Bulletins issued;
 - f. the Performance Security or Performance Securing Declaration;
 - g. the Procuring Entity's Notice to Execute Framework Agreement;
 - h. Mini Competition, when necessary; and
 - i. Call-Offs.

Article II
DURATION

The term of this Agreement shall be from _____ to _____ unless sooner revoked by both parties or until the full exhaustion of the maximum quantities;

Article III
CONSIDERATION

For the consideration of one peso (Php 1.00), **PS** has the option to purchase any or all of the items in the Framework Agreement List through the issuance of Call-off and the **Supplier** commits to deliver the goods and perform the services subject to the conditions of the Call-off.

Article IV
PERFECTION OF PROCUREMENT CONTRACT

The Framework Agreement being an option contract, a procurement contract is perfected only when the Procuring Entity exercises the option to procure any item from the Framework Agreement List through the issuance of a Call-off.

Article V
OBLIGATION TO ANSWER A CALL-OFF

Once **PS** issues a Call-off, the **Supplier** is bound to deliver the goods or perform the services identified at the time and date specified in the Call-off. All rules and guidelines governing the implementation of procurement contracts under RA No. 9184 and its revised IRR shall be applicable.

Failure on the part of the **Supplier** to deliver goods or perform the services shall warrant the forfeiture of performance security or performance securing declaration and imposition of liquidated damages as provided for in the Guidelines on the use of Framework Agreement by all Procuring Entities without prejudice to all other applicable sanctions.

**Article VI
TERMS AND CONDITIONS**

The terms and conditions of this Framework Agreement shall be governed by Guidelines on the Use of Framework Agreement by all Procuring Entity and all relevant issuance of the GPPB.

IN WITNESS whereof, the parties hereto have caused this Agreement to be executed in accordance with the laws of the Republic of the Philippines, on the day and year first above written.

PROCUREMENT SERVICE

[COMPANY]

By signing this Agreement, I also confirm that I am authorized to sign on behalf of PS.

By signing this Agreement, I also confirm that I am authorised to sign on behalf of [the Company].

LLOYD CHRISTOPHER A. LAO
Undersecretary/OIC-Executive Director

[Name]
Authorized Representative

WITNESSES

JASONMER L. UAYAN
*OIC-Director IV, Procurement Group
Procurement Service*

[NAME]
Representation

ACKNOWLEDGMENT

REPUBLIC OF THE PHILIPPINES }
CITY OF MANILA }

S.S

BEFORE ME, a Notary Public for and in the City of Manila this ___ day of _____ 2020 appeared the following persons presenting to me their respective identifications, to wit:

Name	Competent Evidence of Identity	Date & Place of Issue
LLOYD CHRISTOPHER A. LAO		

known to me and to me known to be the same persons who executed and voluntarily signed the foregoing FRAMEWORK AGREEMENT which they acknowledged before me as their own free and voluntary act and deed and with full authority to sign in that capacity.

This instrument refers to the FRAMEWORK AGREEMENT FOR THE _____ and consists of _____ (__) pages including this page where the Acknowledgment is written, duly signed by the parties and their instrumental witnesses thereof.

WITNESS MY HAND AND SEAL on the date and place above-written.

Doc. No. ____;

Page No. ____;

Book No. ____;

Series of 20

JOINT VENTURE AGREEMENT

KNOW ALL MEN BY THESE PRESENTS:

This **JOINT VENTURE AGREEMENT** (hereinafter referred to as the "Agreement"), entered into this _____ day of _____ 20__ at _____ City, Philippines by and among:

_____. a domestic corporation duly organized, registered and existing under and by virtue of the laws of the Republic of the Philippines, with office address at _____, represented by its _____, _____, hereinafter referred to as "_____";
- and -

_____. a domestic corporation duly organized, registered and existing under and by virtue of the laws of the Republic of the Philippines, with office address at _____, represented by its _____, _____, hereinafter referred to as "_____";
- and -

_____ a foreign corporation organized and existing under and by virtue of the laws of _____, represented by its _____, _____, hereinafter referred to as "_____";

(Henceforth collectively referred to as the "**Parties**")

WITNESSETH: That

WHEREAS, the Procurement Service (PS) has recently published an Invitation to Apply for Eligibility and to Bid for the Supply and Delivery of _____ for the _____ ;

WHEREAS, the parties have agreed to pool their resources together to form the "_____ Joint Venture", hereinafter referred to as the Joint Venture, under the laws of the Philippines, for the purpose of participating in the abovementioned procurement of PS-DBM;

NOW, THEREFORE, for and in consideration of the foregoing premises and the covenants hereto set forth, the Parties have agreed as follows:

**ARTICLE I
ORGANIZATION OF THE JOINT VENTURE**

SECTION 1. Formation – The Parties do hereby agree and bind themselves to establish, form and organize a Joint Venture pursuant to the laws of the Republic of the Philippines, in order for the JV to carry on the purposes and objectives for which it is created;

SECTION 2. Name – The name and style under which the JV shall be conducted is “ _____ ”;

SECTION 3. Principal Place of Business – The JV shall maintain its principal place of business at _____ ;

SECTION 4. Preparation and Documentation – The Parties shall secure and/or execute such certifications, documents, deeds and instruments as may be required by the laws of the Republic of the Philippines for the realization of the JV and in compliance with the Project. Further, they shall do all other acts and things requisite for the continuation of the JV pursuant to applicable laws;

SECTION 5. The Joint Venture shall be represented by the _____ in all biddings, related procurement transactions and other official dealings that it shall enter into with the PS-DBM and third parties, such transactions to include, among others, the submission of eligibility documents, bids, registration documents obtaining bonds, performing the principal contract in the event that the contract is awarded in favor of the Joint Venture, receipt of payment for goods delivered, and similar and related activities.

SECTION 6. The period of the Joint Venture shall begin upon execution of this Agreement and shall continue until the complete performance of its contractual obligations to PS-DBM, as described in Article II hereof, or upon its termination for material breach of any term or condition of this Agreement, by service of a written statement in English on the other Party, not less than 90 days prior to the intended date termination

**ARTICLE II
PURPOSE**

SECTION 1. The primary purpose of the Joint Venture is to participate in the public bidding to be conducted by the DBM-PS Bids and Awards Committee for the supply and delivery of _____ for the _____ .

SECTION 2. If the above-described contract/s is/are awarded to the Joint Venture, the Joint Venture shall undertake the performance thereof to PS-DBM, and such other incidental activities necessary for the completion of its contractual obligations.

**ARTICLE III
SOLIDARY LIABILITY OF THE PARTIES**

SECTION 1. In the performance of the contract/s that may be awarded to the Joint Venture by the PS-DBM, and all other related activities/obligations, as described in Article II hereof, the Parties bind themselves jointly and solidarily, in the concept of solidarily debtors, subject to the right of reimbursement, as provided in the relevant provisions of the Civil Code of the Philippines.

**ARTICLE IV
CONTRIBUTION AND OTHER ARRANGEMENTS**

SECTION 1. Contribution – The Parties shall contribute the amount of _____ (Php) to support the financial requirements of the Joint Venture, in the following proportion:

A.	-	P	.00
B.	-	<u>P</u>	<u>.00</u>
TOTAL		P	.00

Additional contributions to the Joint Venture shall be made as may be required for contract implementation. In addition, ____ shall contribute any labor and contract management requirements.

SECTION 2. Profit Sharing – The share of the Parties to the JV from any profit derived or obtained from the implementation and execution of the Project shall be distributed pro rata to each, in accordance with the contribution and resources each has provided to the JV;

SECTION 3. Liquidation and Distributions – Any sum remaining after deducting from the total of all moneys or benefits received for the performance of the contract, all costs incurred by the JV after award of the contract for the Project pursuant to the accounting practices established for the JV, shall be distributed in accordance with the relative balances in the accounts of each Party pursuant to Sec.1 of this Article upon completion, final accounting, termination and liquidation of the JV. In the event of liquidation and termination of JV, and after taking into account the shares of the Parties in all income, gain, deductions, expenses,

and losses, should the account of a Party contain a negative balance, such Party shall contribute cash to the JV sufficient to restore the said balance to zero;

SECTION 4. Sharing of Burden of a Net Loss – In case a net loss is incurred, additional contributions shall be made by the Parties in accordance with their respective shares.

ARTICLE V
MISCELLANEOUS PROVISIONS

SECTION 1. The provisions of the Instructions to Bidders, Supplemental Bid Bulletin, and other bidding documents issued by the PS-DBM in relation to the contract described in Article II hereof, shall be deemed incorporated in this Agreement and made an integral part thereof.

SECTION 2. This Agreement shall be binding upon and inure to the benefit of the Parties and their respective successors and assigns.

SECTION 3. The Parties herein are duly represented by their authorized officers.

SECTION 4. Governing Law - This Agreement shall be governed by and construed according to the laws of the Republic of the Philippines. Venue of any court action arising from this Agreement shall be exclusively laid before the proper court of the _____, Philippines.

IN WITNESS WHEREOF, the parties have set their hands and affixed their signatures on the date and place first above-stated.

Signed in the Presence of:

ACKNOWLEDGMENT

REPUBLIC OF THE PHILIPPINES)
CITY/MUNICIPALITY OF _____) S.S.
PROVINCE OF (in the case of Municipality)

BEFORE ME, a Notary Public for and in the City/Municipality of ____(indicate also the Province in the case of Municipality____, this _____ day of ____(month & year)____ personally appeared the following:

Name	ID Name, Number and Validity Date
------	-----------------------------------

Known to me and to me known to be the same persons who executed the foregoing instrument and they acknowledge to me that the same is their free and voluntary act and deed and that of the corporation(s) they represent.

This instrument refers to a Joint Venture Agreement consisting of _____ pages, including the page on which this Acknowledgement is written, and signed by the parties and their instrumental witnesses.

WITNESS MY HAND AND NOTARIAL SEAL on the place and on the date first above written.

NAME OF NOTARY PUBLIC

Serial No. of Commission _____

Notary Public for _____ until _____

Roll of Attorneys No. _____

PTR No. __, [date issued], [place issued]

IBP No. __, [date issued], [place issued]

Doc. No. ____

Page No. ____

Book No. ____

Series of ____.

Note:

The identification card shall be at least one of those acceptable proofs of identity as identified under the provisions of the 2004 Rules on Notarial Practice.

“Sec. 12. Competent Evidence of Identity – The phrase “competent evidence of identity” refers to the identification of an individual based on:

At least one current identification document issued by an official agency bearing the photograph and signature of the individual, such as but not limited to, passport, driver’s license, Professional Regulations Commission ID, National Bureau of Investigation clearance, police clearance, postal ID, voter’s ID, Barangay certification, Government Service and Insurance System (GSIS) e-card, Social Security System (SSS) card, Philhealth card, senior citizen card, Overseas Workers Welfare Administration (OWWA) ID, OFW ID, seaman’s book, alien certificate of registration/immigrant certificate of registration, government office ID, certification from the National Council for the Welfare of Disabled Persons (NCWDP), Department of Social Welfare and Development (DSWD) certification.

SUPPLIER'S LETTERHEAD

Date

**Chairperson
DBM-PS Bids and Awards Committee II
Paco, Manila**

Dear Sir:

This has reference to Public Bidding No. _____ for _____ (Name of Project) _____.
_____ (Name of Company) _____ respectfully requests for the following:

- () Withdraw of Bid Submissions
- () Refund of Bid Security
(Attached is a photocopy of the Procurement Service Official Receipt)
- () Cancellation of Credit Line Certificate

It is understood that _____ waives its right to file any motion for reconsideration and/pr protest in connection with the above-cited Public Bidding Project.

Thank you.

Very truly yours,

Authorized Signatory for the Company

Form of Performance Security (Bank Guarantee)

To : Procurement Service
PS Complex, Cristobal St.,
Paco, Manila

WHEREAS, _____ (*Name and Address of Supplier*) (hereinafter called "the Supplier") has undertaken, in pursuance of Notice to Execute Framework Agreement (NEFA) No. _____ dated _____ to execute (*Name of Contract and Brief Description*) (hereinafter called "the Contract");

AND WHEREAS, it has been stipulated by you in the said Contract that the Supplier shall furnish you with a Bank Guarantee by a recognized bank for the sum specified therein as security for compliance with his obligations in accordance with the Contract;

AND WHEREAS, we have agreed to give the Supplier such a Bank Guarantee;

NOW THEREFORE, we hereby affirm that we are the Guarantor and responsible to you, on behalf of the Supplier, up to a total of [*Amount of Guarantee*] proportions of currencies in which the Contract Price is payable, and we undertake to pay you, upon your first written demand and without cavil or argument, any sum or sums within the limits of [*Amount of Guarantee*] as aforesaid without your needing to prove or to show grounds or reasons for your demand for the sum specified therein.

We hereby waive the necessity of your demanding the said debt from the Supplier before presenting us with the demand.

We further agree that no change or addition to or other modification of the terms of the Contract to be performed thereunder or of any of the Contract documents which may be made between you and the Supplier shall in any way release us from any liability under this guarantee, and we hereby waive notice of any such change, addition or modification.

This guarantee shall be valid until the date of issue of the Final Acceptance [Inspection, & Certification of Acceptance Report(I.C.A.R)].

SIGNATURE AND SEAL OF THE
GUARANTOR

NAME OF BANK

ADDRESS

DATE

BID SECURING DECLARATION FORM

REPUBLIC OF THE PHILIPPINES)
CITY OF _____) S.S.

X-----X

BID SECURING DECLARATION
Invitation to Bid: *Framework Agreement PB No. 20-064-2*

To: *Procurement Service*
PS Complex, RR Road
Cristobal St., Paco, Manila

I/We, the undersigned, declare that:

1. I/We understand that, according to your conditions, bids must be supported by a Bid Security, which may be in the form of a Bid-Securing Declaration.
2. I/We accept that: (a) I/we will be automatically disqualified from bidding for any contract with any procuring entity for a period of two (2) years upon receipt of your Blacklisting order; and, (b) I/we will pay the applicable fine provided under Section 6 of the Guidelines on the Use of Bid Securing Declaration, within fifteen (15) days from receipt of the written demand by the procuring entity for the commission of acts resulting to the enforcement of the bid securing declaration under Sections 23.1(b), 34.2, 40.1 and 69.1, except 69.1(f), of the IRR of RA 9184; without prejudice to other legal action the government may undertake.
3. I/We understand that this Bid Securing Declaration shall cease to be valid on the following circumstances:
 - (a) Upon expiration of the bid validity period, or any extension thereof pursuant to your request;
 - (b) I am/we are declared ineligible or post-disqualified upon receipt of your notice to such effect, and (i) I/we failed to timely file a request for reconsideration or (ii) I/we filed a waiver to avail of said right;

(c) I am/we are declared the bidder with the Lowest Calculated Responsive Bid, and I/we have furnished the performance security and signed the Contract.

IN WITNESS WHEREOF, I/We have hereunto set my/our hand/s this ____ day of [month] [year] at [place of execution].

[Insert NAME OF BIDDER'S AUTHORIZED REPRESENTATIVE]

[Insert Signatory's Legal Capacity]

Affiant

SUBSCRIBED AND SWORN to before me this ____ day of [month] [year] at [place of execution], Philippines. Affiant/s known to me, and known to be the same person/s in the exhibited [insert type of government identification card used*], with his/her photograph and signature appearing thereon, with no. _____ issued on _____ at _____.

Witness my hand and seal this ____ day of [month] [year].

NAME OF NOTARY PUBLIC

Serial No. of Commission _____

Notary Public for _____ until _____

Roll of Attorney's No. _____

PTR No. _____ [date issued], [place issued]

IBP No. _____ [date issued], [place issued]

Doc. No. _____

Page No. _____

Book No. _____

Series of _____.

**The identification card shall be at least one of those acceptable proofs of identity as identified under the provisions of the 2004 Rules on Notarial Practice.*

"Sec. 12. Competent Evidence of Identity – The phrase "competent evidence of identity" refers to the identification of an individual based on:

At least one current identification document issued by an official agency bearing the photograph and signature of the individual, such as but not limited to, passport, driver's license, Professional Regulations Commission ID, National Bureau of Investigation clearance, police clearance, postal ID, voter's ID, Barangay certification, Government Service and Insurance System (GSIS) e-card, Social Security System (SSS) card, Philhealth card, senior citizen card, Overseas Workers Welfare Administration (OWWA) ID, OFW ID, seaman's book, alien certificate of registration/immigrant certificate of registration, government office ID, certification from the National Council for the Welfare of Disabled Persons (NCWDP), Department of Social Welfare and Development (DSWD) certification

Performance Securing Declaration (Revised)

[if used as an alternative performance security but it is not required to be submitted with the Bid, as it shall be submitted within ten (10) days after receiving the Notice to Execute Framework Agreement (NEFA)]

REPUBLIC OF THE PHILIPPINES)
CITY OF _____) S.S.

PERFORMANCE SECURING DECLARATION
Invitation to Bid: Framework Agreement PB No. 20-064-2

To: *Procurement Service*
PS Complex, RR Road
Cristobal St., Paco, Manila

I/We, the undersigned, declare that:

1. I/We understand that, according to your conditions, to guarantee the faithful performance by the supplier/distributor/manufacturer/contractor/consultant of its obligations under the Contract, I/we shall submit a Performance Securing Declaration within a maximum period of ten (10) calendar days from the receipt of the Notice to Execute Framework Agreement (NEFA) prior to the signing of the Contract.
2. I/We accept that: I/we will be automatically disqualified from bidding for any procurement contract with any procuring entity for a period of one (1) year for the first offense, or two (2) years **for the second offense**, upon receipt of your Blacklisting Order if I/We have violated my/our obligations under the Contract;
3. I/We understand that this Performance Securing Declaration shall cease to be valid upon:
 - (a) issuance by the Procuring Entity of the Certificate of Final Acceptance, subject to the following conditions:
 - i. Procuring Entity has no claims filed against the contract awardee;
 - ii. It has no claims for labor and materials filed against the contractor; and
 - iii. Other terms of the contract; or
 - (b) replacement by the winning bidder of the submitted PSD with a performance security in any of the prescribed forms under Section 39.2 of the 2016 revised IRR

of RA No. 9184 as required by the end-user.

IN WITNESS WHEREOF, I/We have hereunto set my/our hand/s this ____ day of [month] [year] at [place of execution].

[Insert NAME OF BIDDER'S AUTHORIZED
REPRESENTATIVE]

[Insert Signatory's Legal Capacity]

Affiant

SUBSCRIBED AND SWORN to before me this ____ day of [month] [year] at [place of execution], Philippines. Affiant/s known to me, and known to be the same person/s in the exhibited [insert type of government identification card used*], with his/her photograph and signature appearing thereon, with no. _____ issued on _____ at _____.

Witness my hand and seal this ____ day of [month] [year].

NAME OF NOTARY PUBLIC

Serial No. of Commission _____

Notary Public for _____ until _____

Roll of Attorney's No. _____

PTR No. _____ [date issued], [place issued]

IBP No. _____ [date issued], [place issued]

Doc. No. _____

Page No. _____

Book No. _____

Series of _____.

**The identification card shall be at least one of those acceptable proofs of identity as identified under the provisions of the 2004 Rules on Notarial Practice.*

"Sec. 12. Competent Evidence of Identity – The phrase "competent evidence of identity" refers to the identification of an individual based on:

At least one current identification document issued by an official agency bearing the photograph and signature of the individual, such as but not limited to, passport, driver's license, Professional Regulations Commission ID, National Bureau of Investigation clearance, police clearance, postal ID, voter's ID, Barangay certification, Government Service and Insurance System (GSIS) e-card, Social Security System (SSS) card, Philhealth card, senior citizen card, Overseas Workers Welfare Administration (OWWA) ID, OFW ID, seaman's book, alien certificate of registration/immigrant certificate of registration, government office ID, certification from the National Council for the Welfare of Disabled Persons (NCWDP), Department of Social Welfare and Development (DSWD) certification

Contract Agreement Form for the Procurement of Goods (Revised)

[Not required to be submitted with the Bid, but it shall be submitted within ten (10) days after receiving the Notice to Execute Framework Agreement (NEFA)]

CONTRACT AGREEMENT

THIS AGREEMENT made the ____ day of _____ 20____ between [name of PROCURING ENTITY] of the Philippines (hereinafter called “the Entity”) of the one part and [name of Supplier] of [city and country of Supplier] (hereinafter called “the Supplier”) of the other part;

WHEREAS, the Entity invited Bids for certain goods and ancillary services, particularly [brief description of goods and services] and has accepted a Bid by the Supplier for the supply of those goods and services in the sum of [*contract price in words and figures in specified currency*] (hereinafter called “the Contract Price”).

NOW THIS AGREEMENT WITNESSETH AS FOLLOWS:

1. In this Agreement words and expressions shall have the same meanings as are respectively assigned to them in the Conditions of Contract referred to.
2. The following documents as required by the 2016 revised Implementing Rules and Regulations of Republic Act No. 9184 shall be deemed to form and be read and construed as integral part of this Agreement, *viz.*:
 - i. Philippine Bidding Documents (PBDs);
 - ii. Schedule of Requirements;
 - iii. Technical Specifications;
 - iv. General and Special Conditions of Contract; and
 - v. Supplemental or Bid Bulletins, if any

Winning bidder’s bid, including the Eligibility requirements, Technical and Financial Proposals, and all other documents or statements submitted;

Bid form, including all the documents/statements contained in the Bidder’s bidding envelopes, as annexes, and all other documents submitted (*e.g.*, Bidder’s response to request for clarifications on the bid), including corrections to the bid, if any, resulting from the Procuring Entity’s bid evaluation;

Performance Security;

Notice to Execute Framework Agreement (NEFA) of Contract; and the Bidder's conforme thereto; and

Other contract documents that may be required by existing laws and/or the Procuring Entity concerned in the PBDs. **Winning bidder agrees that additional contract documents or information prescribed by the GPPB that are subsequently required for submission after the contract execution, such as the Notice to Proceed, Variation Orders, and Warranty Security, shall likewise form part of the Contract.**

3. In consideration for the sum of *[totalcontract price in words and figures]* or such other sums as may be ascertained, *[Named of the bidder]* agrees to *[state the object of the contract]* in accordance with his/her/its Bid.
4. The *[Name of the procuring entity]* agrees to pay the above-mentioned sum in accordance with the terms of the Bidding.

IN WITNESS whereof the parties hereto have caused this Agreement to be executed in accordance with the laws of the Republic of the Philippines on the day and year first above written.

[Insert Name and Signature]

[Insert Name and Signature]

[Insert Signatory's Legal Capacity]

[Insert Signatory's Legal Capacity]

for:

for:

[Insert Procuring Entity]

[Insert Name of Supplier]

ACKNOWLEDGMENT

REPUBLIC OF THE PHILIPPINES)
CITY/MUNICIPALITY OF _____) S.S.
PROVINCE OF (in the case of Municipality)

BEFORE ME, a Notary Public for and in the City/Municipality of _____ (indicate also the Province in the case of Municipality), this _____ day of _____ (month & year) personally appeared the following:

Name

ID Name, Number and Validity Date

Known to me and to me known to be the same persons who executed the foregoing instrument and they acknowledge to me that the same is their free and voluntary act and deed and that of the corporation(s) they represent.

This instrument refers to a Joint Venture Agreement consisting of _____ pages, including the page on which this Acknowledgement is written, and signed by the parties and their instrumental witnesses.

WITNESS MY HAND AND NOTARIAL SEAL on the place and on the date first above written.

NAME OF NOTARY PUBLIC

Serial No. of Commission _____

Notary Public for _____ until _____

Roll of Attorneys No. _____

PTR No. __, [date issued], [place issued]

IBP No. __, [date issued], [place issued]

Doc. No. ____

Page No. ____

Book No. ____

Series of ____.

The identification card shall be at least one of those acceptable proofs of identity as identified under the provisions of the 2004 Rules on Notarial Practice.

“Sec.12. Competent Evidence of Identity – The phrase “competent evidence of identity” refers to the identification of an individual based on:

At least one current identification document issued by an official agency bearing the photograph and signature of the individual, such as but not limited to, passport, driver’s license, Professional Regulations Commission ID, National Bureau of Investigation clearance, police clearance, postal ID, voter’s ID, Barangay certification, Government Service and Insurance System (GSIS) e-card, Social Security System (SSS) card, Philhealth card, senior citizen card, Overseas Workers Welfare Administration (OWWA) ID, OFW ID, seaman’s book, alien certificate of registration/immigrant certificate of registration, government office ID, certification from the National Council for the Welfare of Disabled Persons (NCWDP), Department of Social Welfare and Development (DSWD) certification

REQUIREMENTS FOR SIMILAR CONTRACT				
No	Item Code	Item Description	UOM	Similar Contract shall refer to:
1	47131812-AF-A01	AIR FRESHENER, aerosol type	can	Aerosol Products
2	47131803-DS-A01	DISINFECTANT SPRAY, aerosol type	can	
3	47131830-FC-A01	FURNITURE CLEANER, aerosol type	can	
4	10191509-IN-A01	INSECTICIDE, aerosol type	can	
5	12191601-AL-E01	ALCOHOL, ethyl, 68%-70%	bottle	Cleaning Supplies
6	47131829-TB-C01	CLEANER, TOILET BOWL AND URINAL	bottle	
7	47131805-CL-P01	CLEANSER, SCOURING POWDER	can	
8	47131811-DE-B01	DETERGENT BAR	each	
9	47131811-DE-P01	DETERGENT POWDER, all purpose	pouch	
10	47131800-CB-S01	DISINFECTANT SOLUTION	container	
11	47131501-RG-C01	RAGS, ALL COTTON	bundle	
12	47131602-SC-N01	SCOURING PAD	pack	
13	26111702-BT-A02	BATTERY, dry cell, AA	pack	Dry Cell Batteries
14	26111702-BT-A01	BATTERY, dry cell, AAA	pack	
15	26111702-BT-A03	BATTERY, dry cell, D	pack	
16	40101604-EF-G01	ELECTRIC INDUSTRIAL FAN,	unit	Electrical Appliances

17	40101604-EF-C01	ELECTRIC FAN, ORBIT type	unit	Electrical Appliances
18	40101604-EF-S01	ELECTRIC FAN, STAND TYPE	unit	
19	40101604-EF-W01	ELECTRIC FAN, WALL TYPE	unit	
20	31201502-TA-E01	TAPE, ELECTRICAL	roll	
21	46191601-FE-M01	FIRE EXTINGUISHER, DRY CHEMICAL	unit	Fire Suppression Product/Systems
22	46191601-FE-H01	FIRE EXTINGUISHER, PURE HCFC	unit	
23	47131604-BR-S01	BROOM, SOFT (TAMBO)	each	Floor Care Products
24	47131604-BR-T01	BROOM, STICK (TINGTING)	each	
25	47131802-FW-P02	FLOOR WAX, PASTE, RED	can	
26	47121804-MP-B01	MOPBUCKET	unit	
27	47131613-MP-H02	MOPHANDLE	each	
28	47131619-MP-R01	MOPHEAD, made of rayon	each	
29	52161535-DV-R01	DIGITAL VOICE RECORDER	unit	Information and Communications Technology Products
30	45121517-DO-C01	DOCUMENT CAMERA, 3.2mp min.	unit	IT Products
31	43202003-DV-W01	DVD REWRITABLE	each	
32	43201827-HD-X02	EXTERNAL HARD DRIVE, 1TB, 2.5"HDD, USB 3.0	unit	
33	43202010-FD-U01	FLASH DRIVE, 16 GB capacity	each	
34	43211708-MO-O01	MOUSE, OPTICAL	unit	

35	45111609-MM-P01	MULTIMEDIA PROJECTOR, 4000 ANSI Lumens min.	unit	IT Products
36	43212102-PR-D02	PRINTER, IMPACT DOT MATRIX, 24 pins, 136 column	unit	
37	43212102-PR-D01	PRINTER, IMPACT DOT MATRIX, 9 pins, 80 columns	unit	
38	43212105-PR-L01	PRINTER, LASER, MONOCHROME	unit	
39	39101605-FL-T04	FLUORESCENT LAMP, 28 WATTS	tube	Lighting Supplies
40	39101628-LB-L01	LED LIGHT BULB, 7 watts max.	each	
41	39101628-LT-L01	LED LINEAR TUBE, 18 watts	tube	
42	44121619-PS-M01	PENCIL SHARPENER	each	Office Device
43	44101602-PU-P01	PUNCHER, paper, heavy duty	each	
44	44121613-SR-P01	STAPLE REMOVER, PLIER TYPE	each	
45	44121615-ST-B01	STAPLER, BINDER TYPE	unit	
46	44121615-ST-S01	STAPLER, STANDARD TYPE	each	
47	44121605-TD-T01	TAPE DISPENSER, TABLE TOP	each	
48	44101602-PB-M01	BINDING AND PUNCHING MACHINE	unit	Office Equipment
49	44101807-CA-C01	CALCULATOR, COMPACT	unit	
50	44101808-CA-S01	CALCULATOR, SCIENTIFIC	unit	
51	44103202-DS-M01	DATING AND STAMPING MACHINE	each	
52	44101714-FX-M01	FACSIMILE MACHINE	unit	
53	44101603-PS-M01	PAPER SHREDDER	unit	

54	44101601-PT-M01	PAPER TRIMMER/CUTTING MACHINE	unit	Office Equipment
55	13111203-AC-F01	ACETATE	roll	Office Supplies
56	44122037-RB-P09	BINDING RING, PLASTIC, 32MM (formerly known as Ring Binder)	bundle	
57	13111201-CF-P01	CARBON FILM, A4	box	
58	13111201-CF-P02	CARBON FILM, LEGAL	box	
59	44121710-CH-W01	CHALK, WHITE ENAMEL	box	
60	60121413-CB-P01	CLEARBOOK, A4 SIZE	each	
61	60121413-CB-P02	CLEARBOOK, LEGAL	Each	
62	44122105-BF-C01	CLIP, BACKFOLD, 19MM	box	
63	44122105-BF-C02	CLIP, BACKFOLD, 25MM	box	
64	44122105-BF-C03	CLIP, BACKFOLD, 32MM	box	
65	44122105-BF-C04	CLIP, BACKFOLD, 50MM	box	
66	44121801-CT-R01	CORRECTION TAPE	each	
67	44121612-BL-H01	CUTTER BLADE	tube	
68	44121612-CU-H01	CUTTER KNIFE	each	
69	44111515-DF-B01	DATA FILE BOX	each	
70	44122011-DF-F01	DATA FOLDER	each	
71	44121506-EN-X02	ENVELOPE, EXPANDING, PLASTIC	each	
72	44111912-ER-B01	ERASER, FELT, FOR BLACKBOARD OR WHITEBOARD	each	

73	60121534-ER-P01	ERASER, PLASTIC OR RUBBER	each	Office Supplies
74	44122118-FA-P01	FASTENER, METAL	box	
75	44111515-FO-X01	FILE ORGANIZER, LEGAL	each	
76	44122018-FT-D01	FILE TAB DIVIDER, A4	set	
77	44122018-FT-D02	FILE TAB DIVIDER, LEGAL	set	Office Supplies
78	44122011-FO-F01	FOLDER, FANCY, A4	bundle	
79	44122011-FO-F02	FOLDER, FANCY, LEGAL	bundle	
80	44122011-FO-L01	FOLDER, L-TYPE, A4 SIZE	pack	
81	44122011-FO-L02	FOLDER, L-TYPE, LEGAL SIZE	pack	
82	44122027-FO-P01	FOLDER, PRESSBOARD	box	
83	44122011-FO-T01	FOLDER, with TAB, A4	pack	
84	44122011-FO-T02	FOLDER, with TAB, LEGAL	pack	
85	31201610-GL-J01	GLUE, all purpose	jars	
86	44122008-IT-T01	INDEX TAB	box	
87	14111609-LL-C01	LOOSELEAF COVER	bundle	
88	44111515-MF-B02	MAGAZINE FILE BOX, LARGE	each	
89	14111514-NP-S02	NOTEPAD, STICK-ON, 2X3	pad	
90	14111514-NP-S03	NOTEPAD, STICK-ON, 3X3	pad	
91	14111514-NP-S04	NOTEPAD, STICK-ON, 3X4	pad	
92	44122104-PC-G01	PAPER CLIP, 32mm	box	

93	44122104-PC-J02	PAPER CLIP, 48mm	box	Office Supplies	
94	55121905-PH-F01	PHILIPPINE NATIONAL FLAG	each		
95	44122101-RU-B01	RUBBER BAND	box		
96	41111604-RU-P02	RULER, PLASTIC, 450MM	each		
97	44121618-SS-S01	SCISSORS	pair		
98	12171703-SI-P01	STAMP PAD INK	bottle		
99	44121905-SP-F01	STAMP PAD, FELT	each		
100	31151804-SW-H01	STAPLE WIRE, HEAVY DUTY, 23/13	box		
101	31151804-SW-S01	STAPLE WIRE, STANDARD	box		
102	31201503-TA-M01	TAPE, MASKING, width: 24mm	roll		
103	31201503-TA-M02	TAPE, MASKING, width: 48mm	roll		
104	31201517-TA-P01	TAPE, PACKAGING, width: 48mm	roll		
105	31201512-TA-T01	TAPE, TRANSPARENT, width: 24mm	roll		
106	31201512-TA-T02	TAPE, TRANSPARENT, width: 48mm	roll		
107	31151507-TW-P01	TWINE, PLASTIC	roll		
108	14111525-CA-A01	CARTOLINA, ASSORTED COLORS	pack		Paper Products
109	14111506-CF-L11	CONTINUOUS FORM, 1 PLY, 280 x 241mm	box		
110	14111506-CF-L12	CONTINUOUS FORM, 1 PLY, 280MM X 378MM	box		
111	14111506-CF-L21	CONTINUOUS FORM, 2 PLY, 280 x 241mm	box		

112	14111506-CF-L22	CONTINUOUS FORM, 2 PLY, 280MM X 378MM	box	Paper Products
113	14111506-CF-L31	CONTINUOUS FORM, 3 PLY, 280 x 241mm	box	
114	14111506-CF-L32	CONTINUOUS FORM, 3 PLY, 280MM X 378MM	box	
115	44121506-EN-D01	ENVELOPE, DOCUMENTARY, for A4 size document	box	
116	44121506-EN-D02	ENVELOPE, DOCUMENTARY, for legal size document	box	
117	44121506-EN-X01	ENVELOPE, EXPANDING, KRAFTBOARD, for legal size	box	
118	44121506-EN-M01	ENVELOPE, MAILING	box	
119	44121504-EN-W01	ENVELOPE, MAILING, WITH WINDOW	box	
120	14111514-NB-S01	NOTEBOOK, STENOGRAPHER	each	
121	14111531-PP-R01	PAD PAPER, RULED	pad	
122	14111507-PP-M01	PAPER, MULTICOPY, 80gsm, A4	ream	
123	14111507-PP-M02	PAPER, MULTICOPY, 80gsm, size: 216mm x 330mm	ream	
124	14111507-PP-C01	PAPER, Multi-Purpose (COPY) A4, 70 gsm.	ream	
125	14111507-PP-C02	PAPER, Multi-Purpose (COPY) Legal, 70 gsm.	ream	
126	14111503-PA-P01	PAPER, PARCHMENT	box	
127	14111818-TH-P02	PAPER, THERMAL, 216mm x 30m	roll	
128	14111531-RE-B01	RECORD BOOK, 300 PAGES	book	

129	14111531-RE-B02	RECORD BOOK, 500 PAGES	book	Paper Products
130	14111704-TT-P01	TOILET TISSUE PAPER	pack	
131	60121124-WR-P01	WRAPPING PAPER	pack	
132	56101504-CM-B01	CHAIR, MONOBLOC, BEIGE	each	Plastic Molded Products
133	56101504-CM-W01	CHAIR, MONOBLOC, WHITE	each	
134	47131601-DU-P01	DUST PAN, non-rigid plastic	each	
135	56101519-TM-S02	MONOBLOC, TABLE, BEIGE	unit	
136	56101519-TM-S01	MONOBLOC, TABLE, WHITE	unit	
137	47121804-MP-B01	MOPBUCKET	unit	Plastic Molded Products
138	47121701-TB-P01	TRASHBAG, plastic, gusseted type, black	roll/pack	
139	47121702-WB-P01	WASTEBASKET, NON RIGID PLASTIC	each	
140	55101524-RA-H01	HANDBOOK ON RA9184	book	Printing Services
141	44121716-MA-F01	MARKER, FLUORESCENT, 3 colors per set	set	Writing Instruments
142	44121708-MP-B01	MARKER, PERMANENT, bullet type, black	each	
143	44121708-MP-B02	MARKER, PERMANENT, bullet type, blue	each	
144	44121708-MP-B03	MARKER, PERMANENT, bullet type, red	each	
145	44121708-MW-B01	MARKER, WHITEBOARD, black	each	
146	44121708-MW-B02	MARKER, WHITEBOARD, blue	each	

147	44121708-MW-B03	MARKER, WHITEBOARD, red	each	Writing Instruments
148	44121706-PE-L01	PENCIL, LEAD WITH ERASER	box	
149	60121524-SP-G01	SIGN PEN, BLACK, liquid/gel ink, 0.5mm needle tip	each	
150	60121524-SP-G02	SIGN PEN, BLUE, liquid/gel ink, 0.5mm needle tip	each	
151	60121524-SP-G03	SIGN PEN, RED, liquid/gel ink, 0.5mm needle tip	each	

